



G SERIES

OPERATION AND MAINTENANCE MANUAL

EPA Certified Wood
Burning Furnaces





CONTENTS

WARRANTY AND SAFETY

Limited Warranty3
 Water Treatment And Testing4
 Water Treatment Policy4
 Recommended Operating Levels4
 Test Parameters and What They Mean4
 Safety Precautions5

FURNACE INSTALLATION GUIDE

Furnace Specification Charts6
 Location6
 Clearance To Combustibles6
 Furnace Foundation7
 Unit Foot Prints7
 Trench7
 Indoor Installation8
 Chimney Installation9
 Combustion Air10
 Wiring And Hydronic Lines10
 Domestic Hot Water12

OPERATING THE FURNACE

Furnace Components13
 Filling The Furnace With Water14
 Firing The Furnace14
 Wood Quality15
 Loading The Furnace (Smokeless Loading)16
 Operating A Gasification Furnace Requirements17
 Controls And Safety Devices18
 How the G Series Gasification Outdoor Furnace Works20

CARE AND MAINTENANCE

Care And Maintenance21
 Cleaning Your Furnace.....22
 Troubleshooting23
 Electrical Troubleshooting25
 G Series Electrical Schematic27
 Instructions For Editing Control Settings28
 Home Network Connection31
 Hardwired Connection31
 Finding an IP Address for Your Furnace32
 Addressing Your Furnace34
 Viewing Your Furnace in a Web Browser35

**RETAIN THIS MANUAL FOR
 FUTURE REFERENCE**

DO NOT THROW AWAY

CANADA

SteelTech Inc.
 Box 158
 Winkler, MB R6W 4A4
 Canada
 Ph. (204) 325-9792
 Fax: (204) 325-9803

USA

SteelTech Inc.
 Box 373
 Walhalla ND, 58282
 Ph. (877) 325-9792
 Fax: (204) 325-9803

info@heatmasterss.com

www.heatmasterss.com





LIFETIME WARRANTY

SteelTech Inc. warrants to the original owner of the G Series outdoor furnace that it is free from defects in workmanship and material, which could cause a leak or malfunction of the firebox or water jacket, and against corrosion (if the instructions in the owners manual for water treatment and maintenance are followed) for the life of the furnace towards the purchase of a new HeatMaster^{SS} furnace, in the following pro-rated schedule.

Warranty Schedule

Coverage in the initial 5 years is 100%

- Year 6 - 7 is 50%
- Year 8 - 9 is 40%
- Year 10 - 15 is 30%
- Year 16 to life is 10%
- All firebrick used in the furnace carries a 2-year warranty.

In addition, all steel including housing, legs, etc. have a pro-rated warranty for a period of 10 years with coverage reducing by 10% per year. Any parts not manufactured by SteelTech Inc. that are used on the furnace - such as thermostats, limit switches, pumps, heat exchangers - carry their own manufacturer's warranty. SteelTech Inc. will not be liable for the cost of shipping, replacement or repair of these parts.

If warranty requires removing or replacing of the furnace or a part on the furnace, SteelTech Inc. is not responsible for the cost of plumbing, replacement of antifreeze or water treatment, shipping cost or any other cost other than the replacement component or furnace.

SteelTech Inc. always has the right to decide if a part or

furnace will be repaired or replaced and will not be liable for any cost not authorized by a SteelTech Inc. representative. SteelTech Inc. does not warranty any damage caused due to negligence and deterioration due to lack of proper ongoing maintenance, physical damage caused by abuse or freeze up, power surges or unauthorized work or modifications to the furnace.

SteelTech Inc. is not liable for any damage or cost which may occur from or during the operation of the furnace or damage incurred due to any heating system failure. The purchaser assumes all responsibility for the care, maintenance, and safe operation of the furnace including adding of approved boiler treatment or water. SteelTech Inc does not warrant door gaskets, exterior paint or finish.

To qualify for warranty all instructions must be followed in the operator's manual, water must be tested and maintained a minimum of once per year, and warranty registration must be on file at SteelTech Inc. within 30 days of purchase along with a copy of the original invoice. No warranty can be approved unless the warranty registration and water test verifications are on file at SteelTech Inc.'s office.

The warranty can be voided by operating the furnace in a manner inconsistent with the owner's manual. SteelTech Inc. reserves the right to change conditions or warranty at any time.

WATER TREATMENT & TESTING

WATER TREATMENT POLICY

To qualify for warranty, water must be tested at a minimum of once per year and water treatment added when necessary.

To take a water sample:

- Locate your water sample bottle, mailing carton and mailing label provided to you by your dealer.
- Open the boiler drain located at the bottom of the rear cabinet of the furnace for 10-15 seconds or until the water runs clear. CAUTION: Water is hot! Use extreme care when pouring into a bucket, and let cool before collecting a sample.
- Fill one of the test bottles at least 1/2 full. Fill out the mailing label provided with the test bottle
- completely, including your email address, the model number and the serial number of your furnace. Make sure to note if the furnace water contains any antifreeze or additional chemicals.
- Place bottle in the tube. Attach top part of the label to sample bottle and bottom part to the outside of mailing tube. Mail to our testing lab. Results can take up to 4 weeks to receive and up to 8 weeks if no email address is on hand at HeatMaster^{SS}.
- You will receive a water test report outlining what must be done (if anything). If any action is necessary, take another sample and mail it to our test lab again to verify the recommended changes have been made.

Add the water treatment through the fill pipe located at the top of the furnace when initially filling the furnace with water or after testing, if needed. Ensure that all drains are closed. It is recommended that water treatment is added at a 1:200 ratio when initially firing the furnace and after that. Additional treatment may have to be added for water with more severe properties or for systems with more chemically demanding requirements.

RECOMMENDED OPERATING LEVELS ARE AS FOLLOWS:

Conductivity: 100 - 4000 ppm

pH: 8.5 – 10.5

Nitrates: no less than 730 ppm

TEST PARAMETERS AND WHAT THEY MEAN

Conductivity

Conductivity is a measurement of minerals in your furnace water. While it is common to have minerals in water, in excess minerals can cause many problems in hydronic systems including scaling and corrosion.

pH

pH is a measurement of alkalinity (hard or soft water). For outdoor furnace water and the water treatment used in outdoor furnaces, it is better to have your water a little harder than softer (recommended pH range is 8.5-10) as the active ingredients in the water treatment neutralize harder water easier than softer water.

Nitrates

Nitrates tested for are a measurement of how much water treatment is in the water. Nitrates measured are active units of water treatment available to neutralize harmful elements in your furnace water. Nitrates also act to neutralize harmful bacteria that may build-up in the furnace water over time.

Glycol

Inhibited glycol provides anti-corrosion elements and freeze protection for outdoor furnaces and is compatible with Outdoor Furnace Water Treatment. Because outdoor furnaces are open to the atmosphere systems and will have fresh water added occasionally, oxygen is always entering the system and will break down the glycol over time to create glycolic acid which will harm your furnace system. When this happens you will be required to drain and flush your furnace system.

It is always suggested to use 100% virgin glycol instead of recycled glycol as it will break down much sooner and create glycolic acid.



SAFETY PRECAUTIONS

Read and understand all precautions before operating the furnace. This furnace needs a periodic inspection for proper operation. It is against federal regulations to operate this furnace in a manner inconsistent with operating instructions in this manual. Save these instructions. Retain this manual as long as you own your G Series outdoor furnace. Carefully read and follow these directions.

DANGER

Do not start the fire with or burn garbage, gasoline, naphtha, engine oil or other inappropriate materials. Only competent persons with a sound understanding of this heating method that are qualified and trained should operate this furnace. Improper firing could result in personal injury and/or damage to the unit and void warranty.

ATTENTION

- USE APPROVED FUELS ONLY!
- The person(s) operating this furnace must comply with all applicable local and state laws or other requirements.
- The person(s) operating this furnace is responsible to run it in such a way so that it does not cause a public or private nuisance. Consult with local authorities prior to installation to adhere to local laws and ordinances.
- DO NOT OVER FIRE THIS HEATER. Attempts to achieve heat output rates that exceed the heater design specifications can result in permanent damage to the heater.

WARNING

- All installations and operations of your furnace must follow state, provincial, and local laws pertaining to operations, wiring, plumbing and building codes.
- All models operate at atmospheric pressure. DO NOT obstruct, block or plug the overflow vent tube in any way, which is located on top of the furnace.
- When installing the furnace, the chimney should never be connected to a chimney flue serving another appliance.

- DO NOT operate furnace in event of power failure. Use caution when opening the firebox and ash cleaning doors. Push the by-pass handle towards the back of the furnace and slowly crack the door open for at least 20 seconds before fully opening the door.

- DO NOT use chemicals or fluids to start the fire.

Risk of Fire:

- DO NOT operate with fuel loading or ash removal doors open.
- DO NOT store fuel or other combustible material within marked installation clearances.
- Inspect and clean flues and chimney regularly.
- This appliance should not be installed in a location where a corrosive atmosphere, flammable gas or vapour, combustible dust or combustible fibers may be present. If flammables are present in the building, ensure ducts, vents and doorways between the rooms are sealed so as to not allow vapours or fibers to travel to the appliance.

CAUTION

- DO NOT start or operate furnace without checking the heating fluid.
- The furnace must be filled until heating fluid comes out the vent pipe on top of the furnace.
- Check for buried cables and utility lines before digging the trench to your furnace.
- For safety and proper temperature control keep all doors closed during operation.
- Hot Surfaces: Keep children away. Do not touch during operation.

ATTENTION: DO NOT CONNECT THIS UNIT TO A CHIMNEY FLUE SERVING ANOTHER APPLIANCE.

FURNACE INSTALLATION GUIDE

Installation should be performed by a qualified installer and must comply with all requirements of the agency having jurisdiction.

	G4000	G7000	G10000
Heat Output Range	15,000 - 100,000 BTU/hr	32,000 - 214,000 BTU/hr	40,850 - 298,816 BTU/hr
Furnace Size (W x H x L)	41 x 79 x 62	51.5 x 81 x 71	51.5 x 81 x 83
Furnace Weight	1353 lbs	1982 lbs	2403 lbs
Firebox Size	23 x 22 x32	29 x 29 x 34	42 x 29 x 34
Firebox Volume	8.5 ft ³	16.5 ft ³	24 ft ³
Chimney Size	6"	6"	6"
Water Capacity	116 gallons	232 gallons	277 gallons
8 Hour Average Efficiency Using Higher Heating Value of Wood	64.3%	76.1%	72%

U.S. ENVIRONMENTAL PROTECTION AGENCY Certified to comply with the 2020 particulate emission standards.

Annual Efficiency rating is calculated using the weighted average test results from the emission test reports for each model.

Efficiency is determined by dividing the total input using the heating value of wood (8600BTU/lb) by the actual heat delivered by the furnace.

LOCATION

Where you install the furnace will have an effect on the efficiency of your furnace. Although the furnace is very well insulated, installing the furnace outdoors will mean some heat loss at the furnace. The furnace will have less heat loss when installed indoors away from the elements that can cause heat loss.

- Maintain an adequate clearance of buildings and combustibles.
- Do not place or store wood within stove installation clearances or within the space required for charging and ash removal.

- Do not store combustible fuels in the same room as the furnace.
- Pile and store wood under shelter.
- For indoor installations where fans are used in the fuel storage area, they should be installed so as to not create any negative pressure in the room where your furnace is burning.
- Contact all governing authorities in your area prior to installation.
- When choosing the location of your furnace you should consider prevailing wind direction, distance from home and wood storage for refueling.
- Give consideration to any effect on your neighbors.

CLEARANCES TO COMBUSTIBLES

Whether installing your G SERIES furnace inside a building or outside, the following clearances to combustibles must always be followed or damage and personal injury may result.

DO NOT STORE COMBUSTIBLE FUELS IN THE SAME SPACE AS THE FURNACE IF INSTALLED INDOORS.

Minimum Clearance to Combustibles

Furnace Roof to Ceiling (Indoor Installations)	6"
Side Walls & Rear	6"
Front (Loading door)	24"

FURNACE FOUNDATION

- Footprint dimensions are shown below.
- Inspect the ground conditions where you intend to install your furnace.
- A cement pad of 4-6" thickness should be used. Cement pads should be a little bigger than the actual furnace. You can also include a 4' extra length front and back so you have a solid working area.
- The furnace can also be placed on 4 cement blocks

- not less than 6" wide x 10" long and 3" thick. Place your blocks so the legs will stand at the center of the blocks.
- The furnace may be installed on a combustible floor provided a noncombustible material such as metal or masonry liner is used in the following areas:
 - Underneath the furnace.
 - At least 16" in front of the furnace and 8" on each side of the firebox and lower combustion chamber doors.

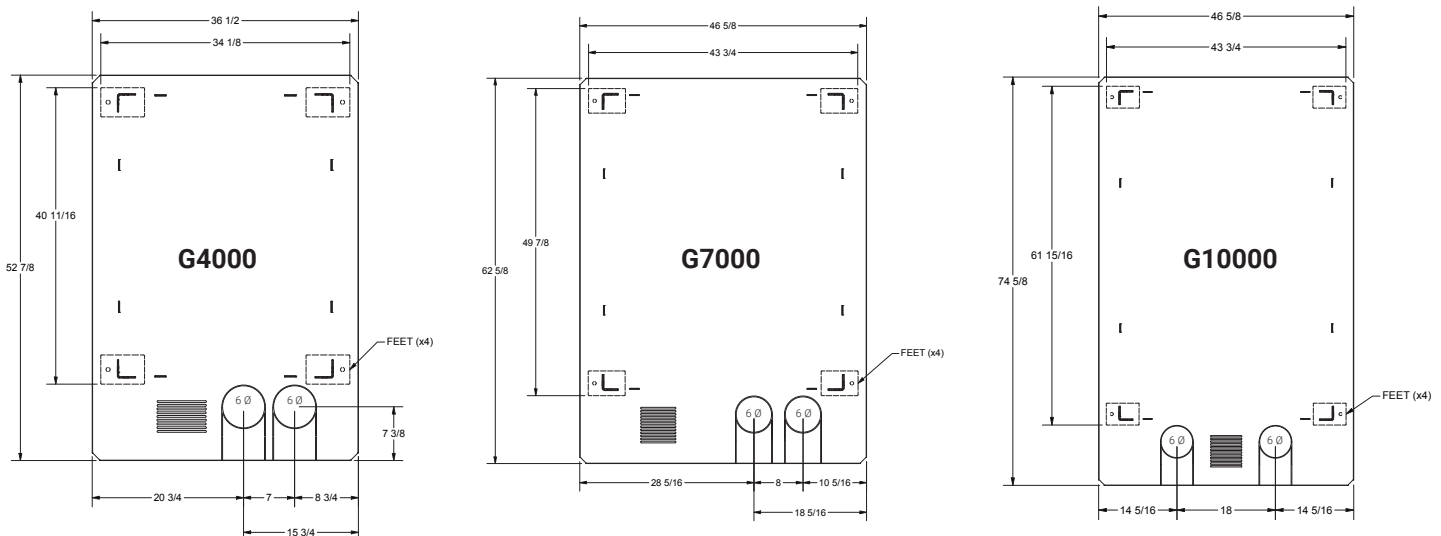

TRENCH

SteelTech Inc. recommends the trench to be 24" to 36" deep, and wide enough to install your water lines. If possible, have a gradual slope in your trench to allow drainage away from your lines and out the trench bottom.

Place a properly rated electrical supply cable at the bottom of the trench and cover with 6 inches of dirt. Install burial rated Cat5 or Cat6 cable or a conduit to allow networking to be set up with the furnace.

Use an underground insulated pipe product like Rhinoflex, available from Heatmaster^{SS}, for your best value and longest lasting underground pipe.

NOTE: If you are installing your water lines under an area where vehicles will cross, you should increase the depth of the trench and use a schedule pipe over your lines to reduce the pressure generated on the lines.



INDOOR INSTALLATION

IMPORTANT: To reduce the risk of fire, follow all local codes and these installation instructions carefully. A fire may be caused by the following:

- Improper installation.
- Storing flammables in the same room as the furnace or wood fuel.
- Not carefully cleaning ash and embers from around the furnace area after loading or cleaning.

ATTENTION: When installing the furnace in a building, always make sure that smoke and CO detectors are properly installed in the same area as the furnace. Outside combustion air may be necessary if:

- The furnace does not draw steady, smells, rolls out smoke, is burning poorly or back-drafts or if any of these symptoms are alleviated by opening a window.
- The building is equipped with a well-sealed vapor barrier and tight-fitting windows and/or has any powered devices that exhaust house air.
- There is excessive condensation on windows in the winter.
- A ventilation system is installed in the building.

Chimney

Note: Incorrect chimney installation will void the warranty.

The chimney on your G Series furnace is a stainless steel chimney. When installing the furnace, the chimney should never be connected to a chimney flue serving another appliance. Make sure the chimney, flue pipe, and draft

inducer fan stay clean and in good condition at all times.

The top of the chimney must extend at least 3.0 feet above the highest point where it exits the roof and be at least 2.0 feet taller than any point of the roof within 10.0 feet. For a new chimney, use an insulated stainless steel system that conforms to type HT (High Temperature) requirements of UL 103 and ULC-S629 and complies with the requirements of Chapter 11 of NFPA 211, Standard for chimneys, fireplaces, vents and solid fuel burning appliances in the USA or CSA B365 installation code for solid fuel burning appliances and equipment in Canada.

The recommended chimney and collar adapters are listed below.

Furnace Chimney Size

G4000	6"
G7000	6"
G10000	6"

This is a draft induced furnace but it is important that the chimney has a good draft to further eliminate any smoke issues.

Note: Using a smaller chimney may cause smoke issues and using larger chimney may negatively affect furnace performance.

ATTENTION: CLEANING OF THE HEAT EXCHANGER, FLUE PIPE, CHIMNEY AND DRAFT INDUCER ARE ESPECIALLY IMPORTANT AT THE END OF THE HEATING SEASON TO MINIMIZE CORROSION DURING THE SUMMER MONTHS CAUSED BY ACCUMULATED ASH.

CHIMNEY INSTALLATION

ATTENTION: Before installing, check with local building codes for information regarding chimney height and distances to adjacent buildings, etc. You may need to obtain a building permit for the installation of this appliance or the chimney.

We recommend that chimneys being installed on our products be installed by professionals who are certified in the USA by NFI (National Fireplace Institute) or in Canada by WETT (Wood Energy Technology Transfer).

Draft problems may occur because of incorrect chimney installation.

IMPORTANT: The furnace room must never be in a negative pressure condition. Negative pressure could result in smoke in the room.

Make sure to follow these simple rules below to ensure proper performance and safety:

- The chimney must be connected using a double wall stainless steel chimney and connector.
- Use only components intended for the brand and model of chimney you are using. Never substitute parts from other chimney brands or fabricate your own components.
- To be safe and effective, the chimney must be installed exactly in accordance with the manufacturer's instructions.
- Use a direct exit whenever possible. A vertical exit with no elbows is always the safest and most trouble-free installation.
- Maximum chimney installation height is 15 ft. Any height longer than 15 ft. must be approved by Heatmaster^{SS} office.
- Maximum horizontal installation from the furnace to the exhaust exit is 3 ft.
- Maximum 8 ft run from elbow to elbow, but keep as short as possible.
- Never use an elbow with a greater than 30-degree bend. 45-degree elbows and tees cannot be used.
- Elbows should never be installed in floor joists or roof attic entries.
- Shields should be used whenever going through floors, attics, and roofs to keep the wood and insulation from getting too hot and possibly catching fire.
- Make sure to follow local building codes.

A chimney connector is the double-wall or single-wall pipe that connects the furnace to the chimney. Chimney connectors are used only to make the connection from the stove to the chimney. They will only be used for installations where chimney extensions are used. For all other installations, the factory provided chimney can be used. Double-wall connectors approved for use with solid-fuel burning appliances must be used.

Information on assembling and installing double-wall connectors and chimneys is provided by the manufacturer and must be followed. Use chimneys and connectors from the same manufacturer as it helps make the assembly and installation easy.

Note: When installing a chimney through a roof, telescoping chimneys can be used to simplify the installation and eliminate the need to cut individual connector sections.

Consult your local dealer about these special pieces.

Roof Penetrations and Clearances

The basic rule is this: The top of the chimney must clear the roof penetration point (the upper edge) by at least 3-feet and must clear anything within a 10-foot radius by at least 2-feet. This includes the peak of the house, parapet, dormer, chimney, or spire. See (figure 1).

If the chimney terminates beyond 10 feet from the ridge of the roof, it must clear the upper penetration of the roof by 3-feet. Notice that the flue still terminates 2-feet above the roof at the 10-foot perimeter.

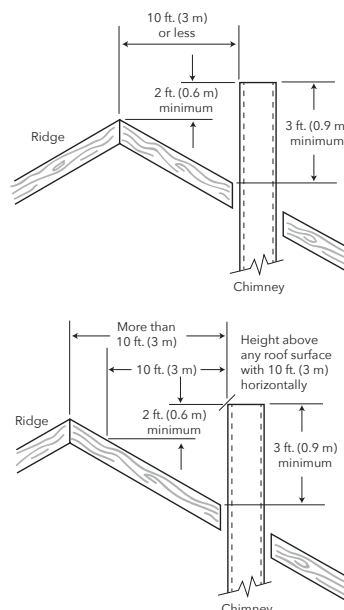

COMBUSTION AIR

Fireplaces, other furnaces, clothes dryers, exhaust fans, and other appliances all draw air from the room in which they are located. Your G Series furnace adds to that draw, making it important to ensure there is an adequate source of fresh air to offset these demands. Otherwise, a negative pressure may be created in the room and starve combustion in the furnace.

1. Determine the volume of space (cubic feet) in the room. Include in the calculation adjacent rooms and areas not closed off by doors. $\text{Volume (CF)} = \text{Length (ft)} \times \text{Width (ft)} \times \text{Height (ft)}$.
2. Determine the air input requirements of all appliances in the space. Add the BTU output of all appliances and round the total to the nearest 1000 BTU per hour.
3. Determine whether the space is 'confined' or 'unconfined' by dividing the total volume of the room by the total input requirements for all appliances in the room.
 - a. If the result is equal to or greater than 50 CF/1000 BTU per hour, then consider the space 'unconfined'.
 - b. If the result is less than 50 CF/1000 BTU per hour, then consider the space 'confined'.
4. For an 'unconfined' space in a conventionally constructed building, the fresh air infiltration through cracks around windows and doors NORMALLY provides adequate air for combustion and ventilation, and therefore no additional make-up air is required.
5. For a 'confined' space or an 'unconfined' space in a building with unusually tight construction, an additional source of make-up air is required. Please consult an HVAC professional to determine the best way to supply make-up air for this type of installation.

WIRING AND HYDRONIC LINES

- All wiring must conform to local codes.
- Use an electrical wire (rated and approved) for underground installations. This wiring can be placed in the same trench below the water lines. A qualified technician must perform the electrical portion of the installation.
- See Page 27 for the furnace wiring diagrams.

Furnace Connection

- Connections to the furnace are clearly marked.
- Return (from the house) are the top ports.
- Supply (to the house) are the bottom ports.
- The installation of isolation valves at both ends of the pump is recommended as well as a valve at the return line. This will allow you to shut off the water supply if repairs or additional heating components are added to the system.
- Your main power is connected to the junction box at the back of the furnace and should be connected by a qualified technician.

Power Requirements

Power Supply	120V 1PH 60 HZ
Max Breaker	15 AMP
Running Load	2.5 Amps
Max Accessory Load	9.5 Amps

Building Connections

It is important to have a hole large enough to accommodate the water lines, insulation, and a protective sleeve through the wall. Attention to sealing this point on both sides is also important

Re-Circulation Pump

Your G Series furnace comes factory equipped with a recirculation pump to ensure there will always be enough flow in the tank.



The pump and loop should be plugged in and valves open at the marked outlet in the rear electrical box whenever the furnace is in use. Under no circumstances should this pump or piping be used to service distribution piping to buildings. The outlets provided for distribution should be connected to separate pumps and piping properly sized for their respective heat load requirements.

The circulation pump has three speeds and should be set according to the model of the furnace.

G4000 - Speed #2

G7000 - Speed #2

G10000 - Speed #3

The recirculation pump must be unplugged whenever the furnace is not filled with water.

Underground Hydronic Lines

Rhinoflex pipe by Heatmaster^{SS} is your best value for long lasting underground pipe with the most efficient insulation used in insulated pipe resulting in minimal heat loss between your furnace and building. Contact your local dealer to purchase.

Hydronic lines (hot water heating lines), whenever buried or encased in cement should not be spliced. Take the necessary steps to ensure they stay dry. This ensures that minimal heat loss occurs. Supply and return lines should be at minimum of 1" and have a rating of 100 PSI capacity of 180° F.

Hint: To easily identify supply and return lines, Rhinoflex Insulated pipe includes one pipe with a black stripe and one pipe blank.

Interior Connections

You may require either a water-to-water (tube and shell or plate) or a water-to-air exchanger (rad) to transfer heat energy from the hot water your furnace has produced. Your plumber or dealer can design and install a system to best fit your needs. The following are examples of basic interior connections. Your dealer carries the necessary parts for installation.

It is important to note that when installing your piping system in your building that you should avoid installation methods that cause too great a restriction in the piping system. Examples of this are reducing pipe size, an excessive amount of joints and elbows, etc.

It is also important to install air bleed valves at high points in the system to avoid an air lock, especially if these points are higher than the furnace. Airlocks can restrict

system flow limiting the BTU's available to your building. This may also lead to your furnace overheating and cause temperature swings in the water feeding the house.

DISCLAIMER: The following information in the interior connections are examples and suggestions only. When installing a furnace and its parts it is best to consult your local dealer or a qualified technician.

Water-To-Water Heat Exchangers

To maintain pressure in an existing boiler system while using an outdoor furnace, a water-to-water heat exchanger is used. The water-to-water exchanger is installed inline on the return side of the existing pressurized boiler system.

Flat Plate Exchanger for Pressurized Boiler Systems

Flat plate exchangers are used with pressurized systems such as boilers. The flat plate transfers heat in to the water in the boiler return line pressurized system while keeping the two systems separate. Because an outdoor furnace is an open system (not pressurized) and the system tied in to this type of application is pressurized, it allows both systems to stay the same while being operational. The water supplied by the outdoor furnace will heat the water in the pressurized system while the present heat source in the pressurized system (such as a boiler) can be used as a backup heat source in case of an emergency or need for additional heat. When connecting the furnace to an existing pressurized boiler system:

- The furnace must not be installed so that it interferes with normal heat delivery of the existing boiler system.
- The furnace must be installed without affecting the operation of the electrical and mechanical safety controls of the original boiler.
- The furnace must provide for a changeover from one fuel to the other without requiring manual adjustment of any controls or components other than the thermostats.
- The furnace must have provisions for preventing, or adequate water capacity within the boiler to prevent damage from loss of circulation due to electrical power failure.
- The furnace must be installed without changing the function of the controls or rewiring the original boiler. A wiring interconnection is permitted. The electrical system of both boilers shall be powered from a single branch circuit without exceptions.

Boiler Safety

- Operate the boiler periodically to ensure that it will operate satisfactorily when needed.
- Do not relocate or bypass any of the safety controls in the original boiler installation.
- The operation of the boiler must be verified for acceptable operation before and after installation of the add-on appliance by a gas fitter who is recognized by the regulatory authority.
- Do not connect to any chimney or vent serving a gas appliance.

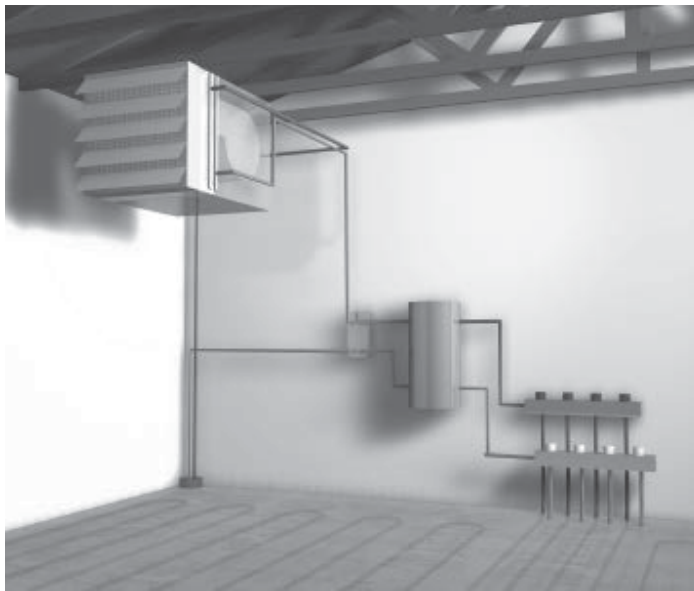

Overhead fan coil installation example

Installation should comply with requirements of CAN/CSA-B365, and changes to the installation should comply with CSA-B139 (for oil-fired boilers), C22.1 (for electric boilers), or CAN/CSA B149.2 (for gas-fired boilers).

DOMESTIC HOT WATER

Flat plate exchanger systems used to pre-heat domestic water tanks are generally more reactive to hot water demands than tube and shell systems. However, tube and shell exchangers hold up better when hard water is present.

Forced Air Furnace (Water-To-Air Exchanger)

The water-to-air heat exchanger must be mounted so that air blows through the fins (coils). The exchanger should be mounted below the A/C coil if possible. The exchanger should be sized to fit existing duct-work and should produce about as many BTU's as the existing heat source. An exchanger that produces too many BTU's will result in uneven heat and the fan stopping too quickly while a heat exchanger that is undersized will not produce the necessary BTU's. The heat exchanger can also be placed into the cold air portion of the duct-work but it is not recommended because some furnaces have an overheat shut off if the fan overheats as a result of blowing hot air instead of cold air.

It is important that the warm-air supply-duct system is constructed of metal in accordance with NFPA 90B-1993, 2-1.1. If the outlet-air temperature of a central furnace exceeds 250 degrees F (121 degrees C) when it is tested in accordance with the requirements for simultaneous firing in 56.4.1 and 56.4.2 of the standard. It is also important that the plenums installed to the furnaces are constructed of metal in accordance with NFPA 90B-1993, 2-1.3.

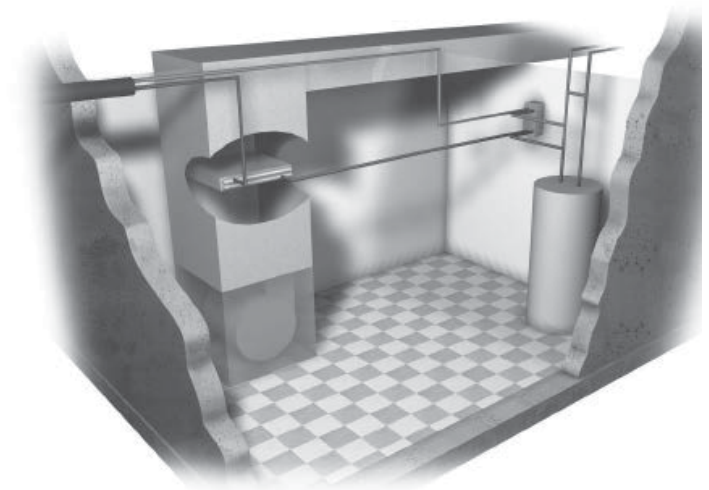

Example of hookup for a forced air furnace and hot water.

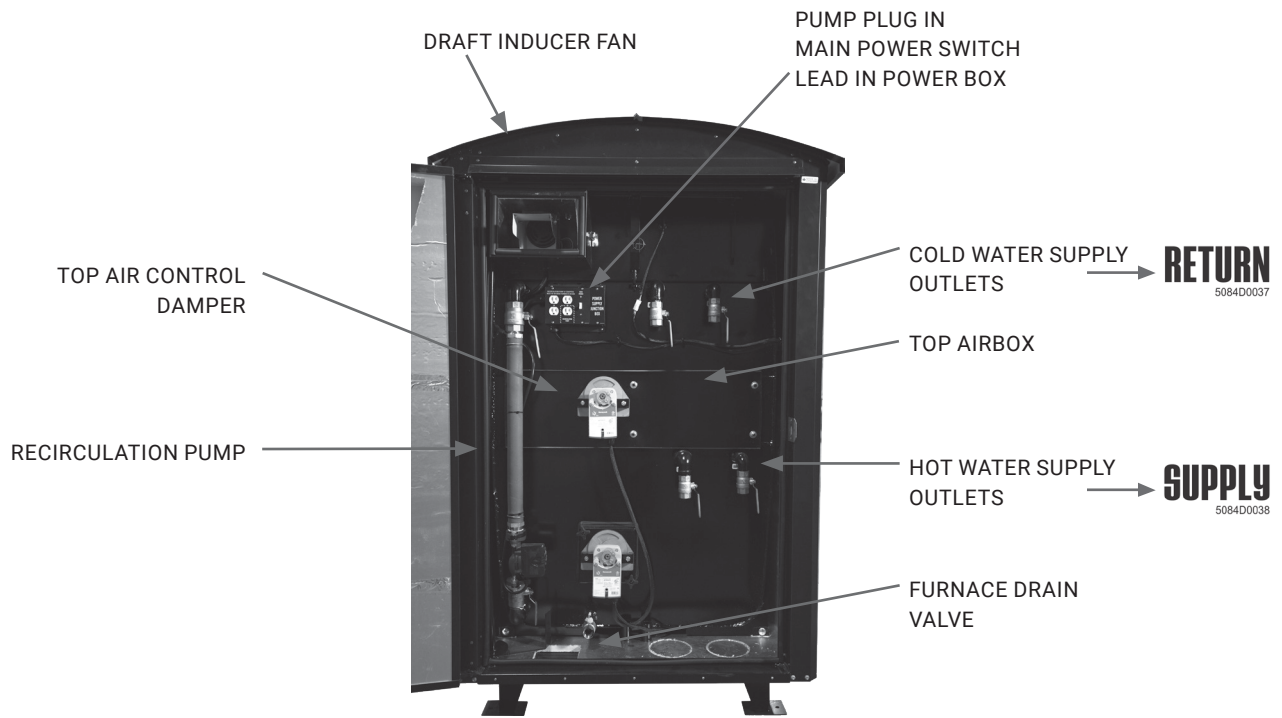
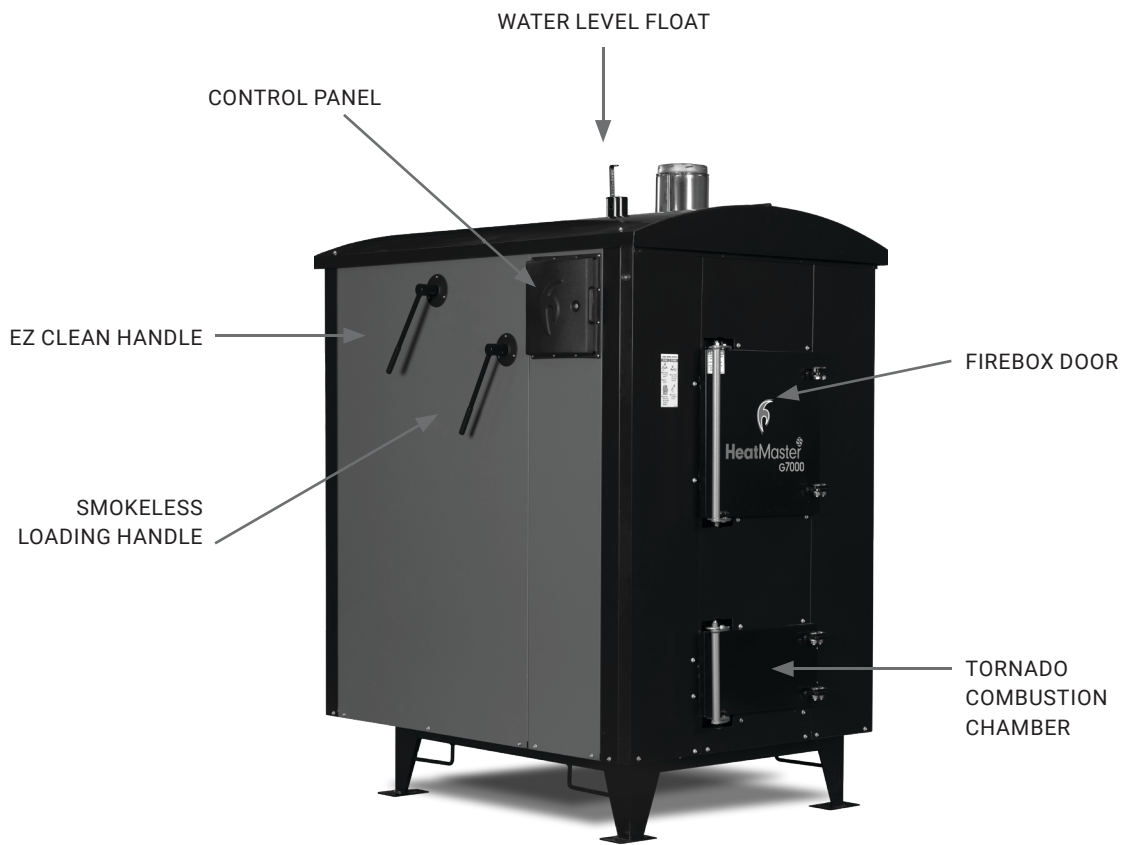

OPERATING THE FURNACE

Filling the Furnace With Water

Your furnace has a vent pipe that protrudes through the roof which is used to fill the furnace with water.

CAUTION: Do not fire the furnace until it is filled with water. Allow the furnace to run for 2 days and check the system water levels and fittings for leaks. Take your initial water sample at this time and be sure that it is sent in for testing.

IMPORTANT: To properly maintain your furnace, test your water every year. Water treatment may need to be added or your furnace may need to be drained and flushed and water treatment added. For information on acquiring this product refer to your local dealer.

Hint: It is recommended that a fill valve is installed inline in the building you're heating with a shut-off valve and oneway check valve (Check local codes for proper installation) to prevent back-flow.

Filling the furnace with the inline valve pushes all the air towards the furnace and out of the vent. Because this furnace is an open system it is normal that water will have to be added annually, depending on the circumstances (6 to 10 gallons is not unusual).

Hint: If any part of the system is higher than the furnace a bleeder valve should be used to make sure all air is removed.

ATTENTION: Your water level will rise as the temperature of the water rises and fall as the water temperature falls. If your water level falls to a low level, first check your water temperature before filling with water again.



Firing the furnace

These furnaces have been specifically designed to burn wood and as such are not intended for burning any other fuels such as rubber, material treated with petroleum products, leaves, paper products, cardboard, plastic or garbage. Burning these fuels in your furnace will result in the warranty of the furnace being voided.

BURN WOOD ONLY: Load carefully or damage may result. On starting an initial fire, use kindling wood and paper, if required. Add heavier fuel gradually until a suitable fire is achieved. The furnace will continue to feed an air supply to the fire until your temperature control reaches set point.

TIP: Develop and keep a bed of ashes in the firebox to keep coals lit during periods of idle. It is common for the fire to go out during idle when first fired in the fall. The ashes will help to insulate the coals and keep them lit.

Note: Your furnace is equipped with a low temperature cut off feature. Anytime the water temperature drops below 140 F, (including your first initial firing of the furnace), you will need to activate the low-temperature bypass function. The silver button (labeled Cold Start) is located on the control panel. When pushed, the furnace will allow the fan to turn on to start your fire.

ATTENTION: On the initial startup, the water jacket will reach what is called the "dew point". This causes sweating inside the firebox which may last a couple of days and is normal.



WOOD QUALITY

This furnace is designed to burn natural wood only. Higher efficiencies and lower emissions generally result when burning air-dried seasoned hardwoods (15-25% moisture content) as compared to softwoods or too green and freshly cut hardwoods.

DO NOT BURN:

1. Garbage.
2. Lawn clippings or yard waste.
3. Materials containing rubber (including tires).
4. Materials containing plastic.
5. Waste petroleum products, paints or paint thinners and asphalt products.
6. Materials containing asbestos.
7. Construction or demolition debris.
8. Railroad ties or pressure-treated wood.
9. Manure or animal remains.
10. Salt-water driftwood or other previously salt water saturated materials.
11. Unseasoned materials.
12. Paper products, cardboard, plywood or particleboard.

The prohibition against burning these materials does not prohibit the use of fire starters made from paper, cardboard, saw-dust, and similar substances for the purpose of starting a fire in an affected wood heater.

Burning these materials may result in a release of toxic fumes or render the heater ineffective and cause smoke. Typically it takes at least 12 months to properly season wood. Seasoned wood looks dark or gray when compared to green wood - but if you split a piece of seasoned wood - it's WHITE on the inside. It has cracks running through each piece, and a lot of little cracks on the inner rings. Unseasoned wood has a wet, fresh looking center, with lighter wood near the edges or ends which have been exposed since cutting. When firewood is very fresh, the bark will be tightly attached.

Keep in mind the diameter of the wood you use. Using wood that is no larger in diameter than 6" will give you a better, more even burn. For anything over 6" diameter it may be best to split the log. Smaller, split wood will season faster, burn better and will be easier to load and stack into the firebox.

Using a moisture meter to test your wood

You can use a moisture meter to test how wet your wood is. A moisture meter will measure the moisture content of a piece of wood by inserting the metal prongs into the grain of the wood. The moisture content will be displayed. To get an accurate reading make sure to use a high-quality moisture meter, split the wood and take at least 2-3 readings from different points of the wood.

Storing wood

Store your wood pile under an open-ended shelter to avoid rain and snow buildup on the pile. Keeping 3 sides open will allow the sun and wind to season the wood. Do not keep the wood in a woodshed or under a tarp during the summer as the moisture that evaporates from the wood will have nowhere to go.



Typical moisture meter

LOADING THE FURNACE - SMOKELESS LOADING HANDLE

WARNING: Risk of fire flashback. Follow these instructions carefully or personal injury may result.

It is always best to load your furnace when it is low on wood. DO NOT open the firebox door within 15 minutes of the furnace reaching temperature or when the firebox is full of wood.

To reduce condensation and creosote formation, load only enough wood to last 12-16 hours.

Before opening any door to the furnace:

1. Push the Smokeless Loading Handle towards the back of the furnace. This will open the smoke bypass so no smoke or flame exits the firebox door when you open it.
2. Crack the firebox door open to the safety catch for at least 15 seconds to allow smoke to exit the chimney and prevent blow-back.
3. Open the door slowly while standing behind the door.
4. Use your ash rake to knock charred wood down and level the coal bed.

Hint: If there is a minimal coal bed left, use the ash rake to rake through the ash bed to stir up the hot coals underneath the surface. Lay small pieces of wood on top of the coals before loading larger pieces of wood.

5. Make sure the air slot in the refractory brick is clear.
6. Load wood carefully using the information and diagram on page 17.
7. Close the firebox door.
8. Close the smoke bypass by pulling the Smokeless Loading Handle over center all the way to the front of the furnace to the closed position.

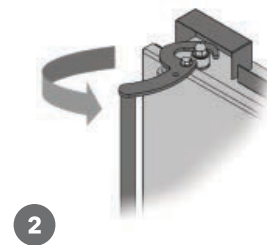
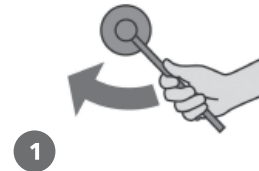



OPERATING A GASIFICATION FURNACE REQUIRES:

- 1. Use Seasoned Wood:** It is always recommended to use dry seasoned wood (15-25% moisture, seasoned 1-2 years) when operating a gasification furnace with a minimal mix of green wood. If required to burn green or wet wood, always mix with a higher ratio of dry or seasoned wood.
- 2. Stacking:** Using the illustration to the right, first stack your primary wood on the coal bed in the firebox so that as the wood gasifies and burns, the wood above it falls on top of the coal bed at the bottom of the firebox to continue the gasification process. Stack your secondary wood around the primary wood to fill the firebox, if necessary.
- 3. Log Sizing:** For ideal operation, log sizing should not exceed 6" in diameter. Exceeding the recommended sizing may result in doming (which only allows for the bottom and/or inside core of the log to burn) or bridging (the wood "hangs up" in the firebox and separates from the coal bed). Pieces of wood larger than 6" should be split into smaller size pieces for use in gasification furnaces.

Improper wood sizing, stacking, or excessive moisture content in the wood may result in the fire going out, improper burning, and extensive creosote buildup not allowing for efficient burning of the wood and eventual furnace malfunction.

For more information on wood quality, follow these links:

EPA's Burnwise Program - <http://www.epa.gov/burnwise>

How to Use a Moisture Meter (Video) -

<http://www.youtube.com/watch?v=jM2WGgRcnm0>

Split, Stack, Cover and Store (Video) -

<http://www.youtube.com/watch?v=yo1--Zrh11s>

WARNING: Risk of fire:

- Do not operate with fuel loading or ash removal doors open.
- Do not store fuel or other combustible material within marked installation clearance.
- Inspect and clean flues and chimney regularly.
- Remove ashes regularly.

CAUTION: Hot surfaces. Keep children away and do not touch during operation.



CONDITIONS AND SAFETY DEVICES

This wood furnace has a manufacturer-set minimum low burn rate that must not be altered. It is against federal regulation to alter this setting or otherwise operate this wood heater in a manner inconsistent with operating instructions in this manual.

Furnace Control

Your HeatMaster^{SS} G Series furnace uses a factory programmed control to maintain your water temperature by using air damper controls and draft inducer fan. The control is located around the corner to the left of the firebox door and requires no user programming or changes. The control displays the water temperature in your furnace, the air damper positions, and any active alarms.

Note: A timer has been programmed into the control to fire the furnace for 3 minutes after 90 minutes of idling and for 3 minutes every 30 minutes after that. This timer will help to keep your coal bed lit during idle periods. The timer settings can be adjusted. See the timer settings section.

Top/Bottom Air Dampers

The damper air percentage is the amount of air being drawn through the furnace to fuel the fire. This feature keeps your furnace burning clean and hot while keeping your water temperature in the preferred range. The dampers are located in the rear cabinet and are mechanical parts that open or close the air injection ports.

Draft Inducer

The draft inducer fan is located at the rear of the furnace on the top and is used to draw air from the air dampers through the furnace. The fan should be on whenever the furnace is in a heating cycle or when the smoke bypass is open.

Smokeless Loading Handle

Use the Smokeless Loading Handle whenever the firebox loading door is open. The bypass handle is located on the side of the furnace and opens a direct exit out of the firebox through the chimney whenever pushed towards the rear of the furnace. This will allow you to check your firebox, fuel and load your furnace without smoke blowing out of the firebox loading door.

Note: Be sure to close the bypass once you have finished loading the furnace and closed the firebox door. The control has a timer that will shut the furnace down if the bypass has been open for 5 minutes.

CAUTION: Do not open any door before opening the Smokeless Loading Handle. Damage to the furnace and personal injury may result.

High Limit Switch

The high limit cut off switch is used to ensure the furnace does not cause damage via runaway fire. It acts as a safety switch by cutting power off to the fan if the water temperature rises above 195 degrees F. If the high limit switch trips, it will have to cool off to approximately 160 F before turning on again.

Alarm LED Light

The LED alarm light is located on the front left corner of the furnace and will blink red if the furnace smoke bypass is open, the furnace is low on water or if the water temperature is too low or too high. It is intended to warn the user of potential problems.

Cold Start Button

The button is located on the control panel in the top right corner. Press the button to bypass the low-temperature function of the control to fire the furnace from a cold start (First firing the furnace or when the water temperature has gone low).

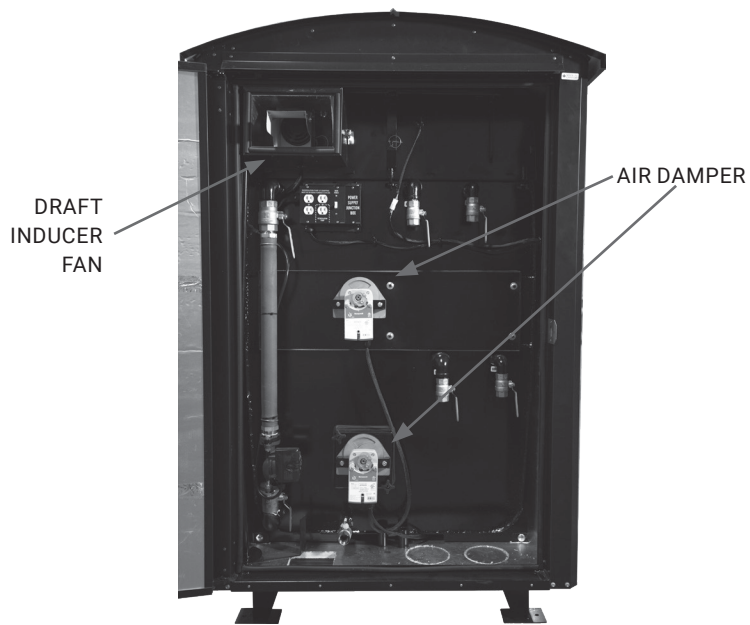
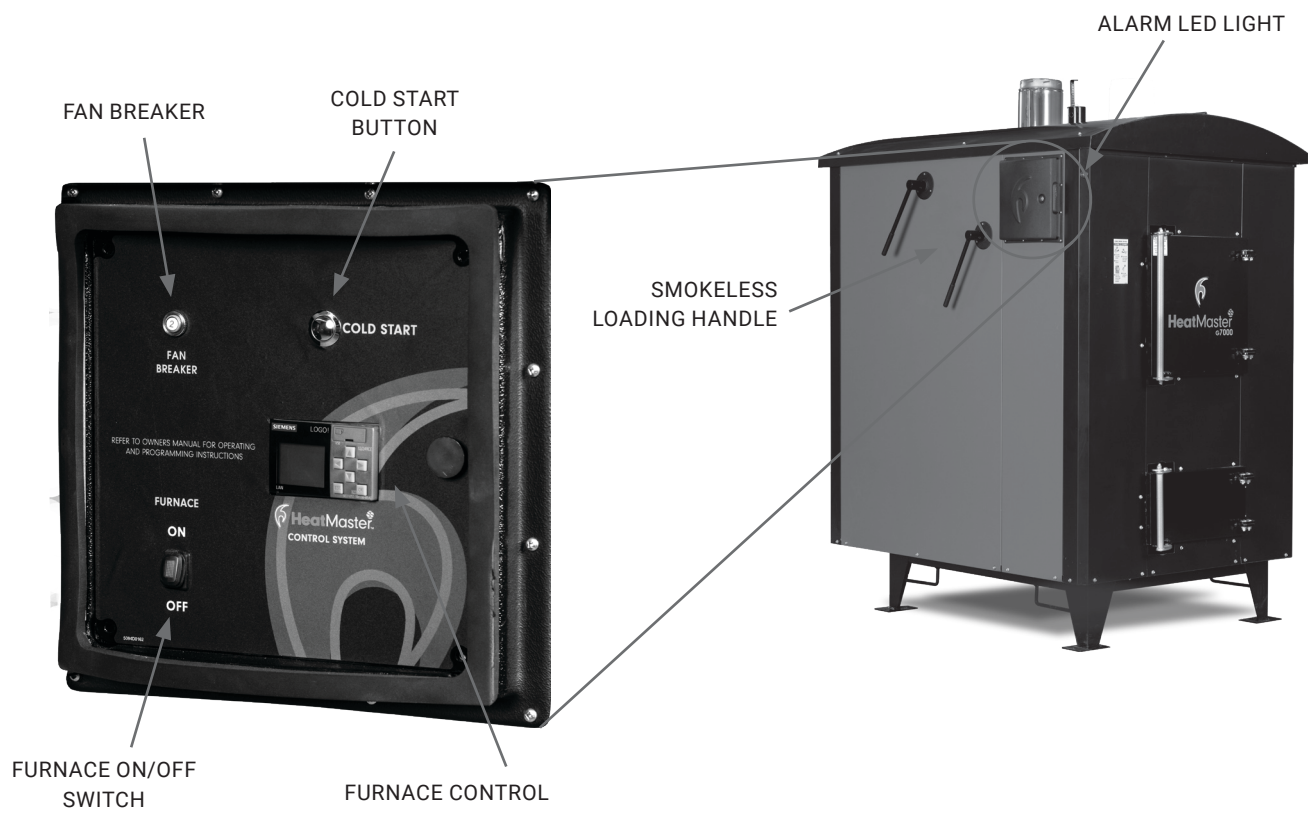

HOW THE G SERIES GASIFICATION OUTDOOR FURNACE WORKS

SteelTech Inc is proud of its reputation for producing innovative outdoor heating methods and our G Series outdoor furnaces are continuing that trend. They operate more efficiently with fewer emissions than other outdoor furnaces. The HeatMaster^{SS} G Series wood furnaces use up to 50% less wood to create the same heat.

How It Works

Wood gas is generated in a high-temperature reaction (>700° F) between the wood and a limited amount of oxygen. The heat and lack of oxygen “bakes” the wood, causing the gases in the wood to release in the form of carbon monoxide, hydrogen and carbon dioxide .

The wood gas mixture that is created in the firebox is then drawn through the base of the fire along with any ash that would come with it and is burned at temperatures around 2000° F in the gasification chamber. This creates a very hot, very clean burn helping you get the most out of your fuel. After the gas is burned, heat is extracted to the water jacket using the heat exchange tubes.

Normal exhaust temperatures are 200-300°F. The most notable indicator of effective gasification is the lack of smoke exiting the chimney. However, often you will see white exhaust that dissipates quickly, which is steam from the wood in the firebox.

The gasification process creates longer burn times and can reduce wood consumption as much as 50% compared to a standard outdoor furnace.

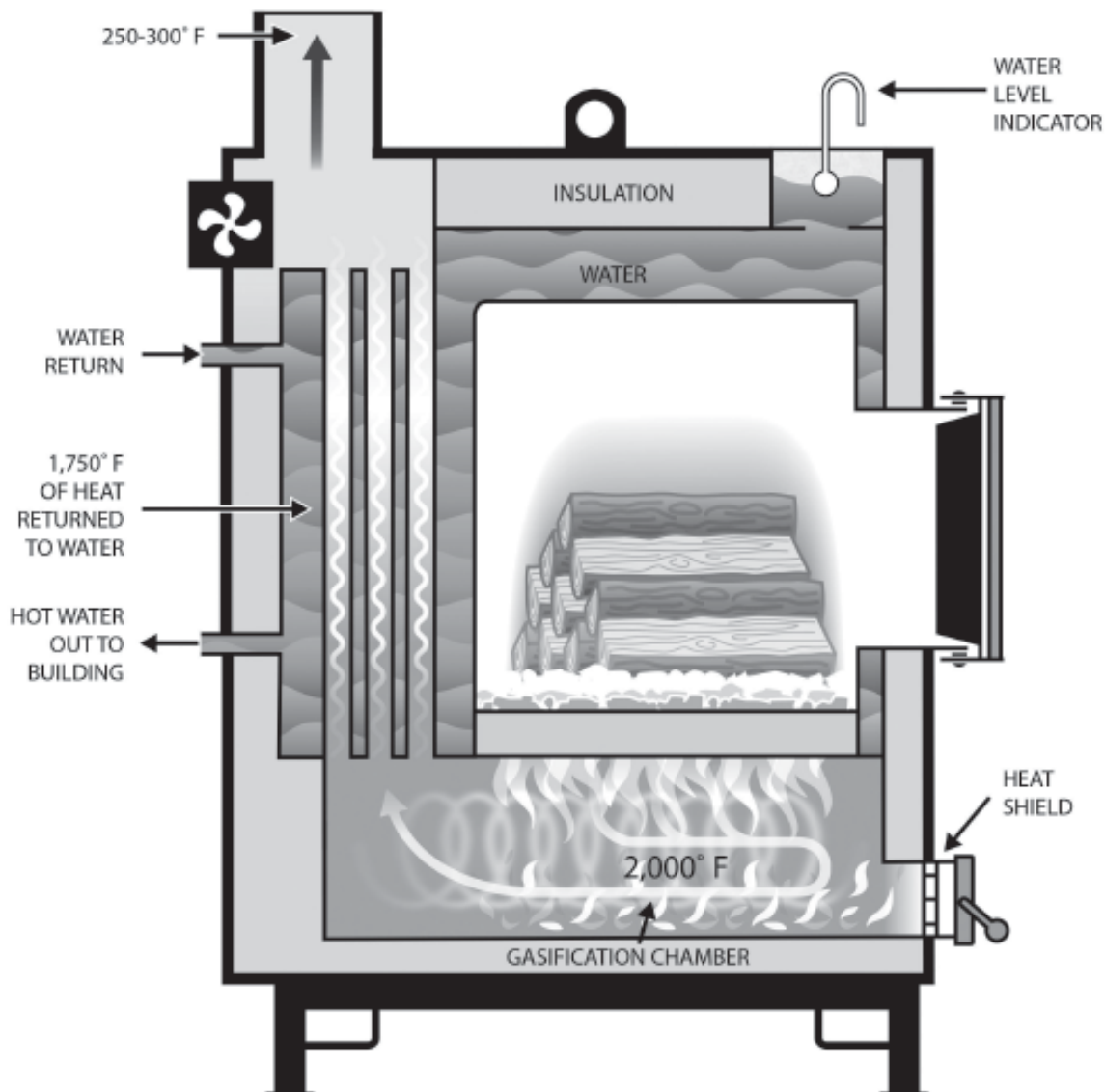



CARE AND MAINTENANCE

To obtain the high level of performance of your furnace, certain maintenance procedures are required periodically.

On a Daily Basis:

- Ensure that all doors are closed and sealing properly. Adjust if necessary.
- Check for creosote buildup in the firebox and lower combustion chamber. Some creosote buildup along the walls, door jamb, and firebox door is normal.
- Check water level.
- Clean heat exchange tubes by aggressively pushing and pulling the lever back and forth at least 5 times.
- Check to make sure the fan and controls are functioning properly. The fan should turn on when the furnace calls for heat. The control display should be functional and keep the water temperature between 160° and 180° F.
- Check for embers or ashes laying on the ground around the furnace and dispose of them.
- Make sure all covers and guards are in place securely.
- Make sure the Smokeless Loading Handle is closed. The handle should be angled towards the front of the furnace.

On a Weekly Basis:

WARNING: Always keep the firebox door open when opening the lower combustion chamber door.

Using the service tools supplied, remove ash from the lower combustion refractory tubes, side, and rear chambers. Dispose of ashes in a metal container away from the stove and wood pile.

See *Cleaning Tools* on page 22.

On a monthly basis:

- Inspect air inlet for creosote build up or blockage.
- Depending on the type and quality of wood being used, ash removal from the firebox may be necessary. For optimal performance, the ash bed in the firebox should not exceed 6-8". If you are burning a wood fuel that leaves quite a bit of ash you may need to clean your firebox out every 2-4 weeks to get optimal performance from your

furnace.

- Check the fan motor and wheel for creosote buildup. The motor and wheel can be easily removed by unplugging the wires to the fan and loosen the nuts on the stainless steel plate.

On a seasonal basis when the furnace is not in use, you will have to:

- Remove all ashes and excess creosote from the firebox, lower combustion chamber, heat exchange tubes and chimney.
- Check all gasket seals to make sure they are sealing. To replace, remove the old seal and residue from the door, scuff the surface where the seal is placed with sandpaper and re-apply high temp silicone. Lay fiberglass rope over silicone and let bond for at least 24 hours before using the furnace again.
- Cover the chimney and crack open the bottom door enough to allow air movement and reduction of condensation within the firebox.
- Make sure your water tank is full and have your water treatment tested and adjusted to manufacturer's specifications. See page 4 for exact specifications.
- If necessary adjust the hinges on each side of the doors to maintain a good seal.

Other maintenance:

- All covers and guards must be in place at all times, except for maintenance or service.
- Care for the exterior of your furnace is minimal.
- The user must wash and remove ash and creosote regularly.
- Ashes should be placed in a metal container with a tight-fitting lid. The closed container should be placed on a non-combustible floor or on the ground well away from all combustible materials before final disposal. If the ashes are disposed of by burial in soil or otherwise locally dispersed, they should be retained in the closed container until all cinders have thoroughly cooled.

Creosote - Formation, and Need for Removal:

When wood is burned slowly, it produces tar and other organic vapors, which combine with expelled moisture to form creosote. The creosote vapors condense in the relatively cool chimney flue of a slow-burning fire. As a result, creosote residue accumulates on the flue lining. When ignited, this creosote makes an extremely hot fire. The chimney and chimney connector should be inspected at least twice a month during the heating season to

determine if a creosote buildup has occurred. If creosote has accumulated it should be removed to reduce the risk of a chimney fire.

CAUTION: Make certain that all electrical power to the furnace and components is shut off. It can be washed using water and a mild nonabrasive cleaner suitable for painted surfaces.

ATTENTION: Avoid direct water pressure

CLEANING YOUR FURNACE

CLEANING TOOLS

Tool #1

- Has a round edge that is meant to be used to clean out the round ports (A) in the refractory.
- The straight edge can be used as a general scraping and cleaning edge.
- This tool is also good for your daily wood poking and fire management tool.

Tool #2

- This tool is to be used to pull ash out from the area to the right of the bottom refractory (B). This tool allows you to reach to the back and behind the refractory to pull out ash.

Tool #3

- This tool is meant to be used, to get a better handle on the Refractory plug and thread out this plug. **WARNING.** Threading out this plug should only be done after the furnace has been allowed to cool down.

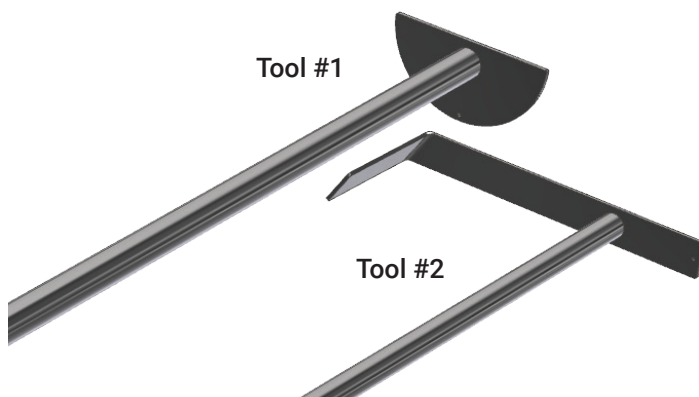



TROUBLESHOOTING

TROUBLESHOOTING TO ENSURE PROPER BURNING & AIR FLOW

If your furnace is showing signs of poor combustion such as smoking while burning, little to no exhaust coming from the chimney, longer than normal heating cycles, or there is a general concern of functionality, use these step by step instructions to assist in troubleshooting.

- Is the control calling for heat? Status = Heating Cycle/ Cold Start Mode. See the Control Settings section of this manual.
- Is the draft fan running in the rear cabinet? If not consult the Draft Fan troubleshooting section in this manual.
- In the rear cabinet, inspect the top and bottom air dampers to ensure they are opening and closing as indicated by the control. If not, refer to the actuator troubleshooting section.
- Use a light piece of paper (like receipt paper) and hold it up to the openings in the damper plates. The paper should be drawn to the openings. If it is not, there is an airflow issue in the furnace.
- Remove the top and bottom air box covers and inspect for blockage. Use receipt paper to check for air flow in the top and bottom air ducts. If there is not a visible blockage but there is not adequate airflow in the ducts inspect the air channels within the firebox.
- Make sure the ash bed is not so high as to block air holes in the panels on the sides of the firebox.
- Make sure the holes in the air channels are clear. If necessary, remove, clean, and replace the air channels. Inspect the burn slot in the firebox floor. Remove any blockage that may be present.
- Remove the burner plug and inspect the right and left burn tubes. Clean as necessary. Always replace the burner plug for operation.
- Inspect and clean the areas to the left and rear of the refractory using the service tools provided with your furnace.
- Remove the flue access cover and inspect that area for

possible blockage. If the area is sticky with creosote inspect the smoke by-pass plate for leakage and adjust as necessary.

- Do the spirals in the heat exchange tubes have full movement up and down? If not inspect the linkage for damage. Flush the heat exchanger tubes with water to loosen them if necessary.
- Remove and inspect the draft fan. Clean the fan and housing if there is creosote or other build up present.
- Inspect the chimney for restrictions and clean if necessary.

More than likely, if there is a problem with the furnace burn or air flow, you will find it by checking these things.

The furnace is running but fails to bring the water temperature up to setpoint:

- Confirm good combustion by following the steps in the previous section.
- Check if the furnace is properly gasifying by opening the bottom door to the Lower Combustion chamber. A flame should be visible only for a short time after opening the door and glowing embers should be present. Keep arms, legs, and head at least 3 feet from the opening. Check fuel type. Poor quality fuel will not provide as many BTU's as high-quality fuel.
- Check water level of the furnace.
- Check to ensure all pumps in the system are running.
- Is the piping between the furnace and buildings properly insulated? Has the insulation become wet from groundwater or a leaking pipe or fitting? Wet insulation around the piping will cause significant heat loss to the ground.
- Check the temperature of water exiting furnace, entering the building being heated and before and after each heat exchanger. Large temperature drops signal large consumption of the BTU's produced by the furnace. If there is a large difference in the water at the top of the tank and the water coming from the supply outlet there is not enough flow in the water tank. (See next topic).
- If everything is functional call your dealer.

If the water temp on the control is hot (170-180° F or higher) but the water temp in the supply line is cool:

- Check to be sure the recirculation pump and the building pumps are operating properly and that the valves in the circulation loop are open to allow flow. The recirculation piping should be hot from top to bottom.
- Check system for flow:
 - » Check to ensure all pumps in the system are running and none are turned the wrong way.
 - » Check filter cartridge for flow blockage (if installed).
 - » Check for air in the system at the exchanger by bleeding off.
 - » Check for closed valves to ensure water flow.
- If no obvious flow issues arise from above system checks, turn off pumps on each line, close ball valves on the return lines. Remove the return line and turn the pump on again. Dump water in a 5-gallon bucket and time how fast it fills up. You should be able to calculate the flow rate in that line. Do this for each line coming off of the furnace to calculate furnace flow rate.

If the furnace water and the building supply lines are hot but buildings do not have heat:

- Check to ensure all pumps in the system are running.
- Check filter cartridge for flow blockage (if installed).
- Check for air in the system at the exchanger by bleeding off.
- Check for closed valves to ensure water flow. Check Temperature of water exiting the furnace, entering the building being heated and before and after each heat exchanger. Large temperature drops signal large consumption of the BTU's produced by the furnace.

If the furnace overheats:

- Close all air inlets and doors on the furnace.
- Retrieve as much heat as possible from the system by turning thermostats up and opening windows until furnace cools down.
- Check that all doors are closing properly and that door gasket is completely sealing.
- Check that the damper plate is opening and closing properly. It should be completely closed when the furnace

temperature is over 180° F.

- Check water level.
- Check to ensure all pumps in the system are running.

If there is a runaway or chimney fire:

- Make sure the firebox and lower combustion chamber doors are tightly closed.
- Close all combustion air inlets on the furnace.

If the furnace has shut down:

- Check to ensure that the unit has power. Is the Main Power switch in the rear electrical box in the ON position? Is there power at the rear receptacles? Is the rocker switch illuminated? Is there a green light on the power supply in the control box?
- Check to ensure the furnace On/Off switch is in the On position.
- Check the water temperature (furnace has a high temperature cut off of 190° and turns on again at 140°).
- Check the control screen for errors that may have shut the furnace down.
- If all checks have not corrected the problem have a technician check the control panel.

If there is a power failure:

- Open all flow-check and zone valves in the system. Depending on the system design, this may allow convective circulation.

Note: This does not apply to gravity systems, as they have no flow-check valves and will continue to operate normally without electricity.

- It is important to remember that the heating systems cannot dispose of a great deal of heat without the circulator(s) running. Avoid over-firing! Fire the furnace cautiously until you are able to determine how quickly the heating system is able to absorb the heat being produced by the furnace.
- When the power has returned, reset all flow-check and zone valves and resume normal operation of the system.

If there is smoke leaking out of the door:

- Check to ensure the door is sealing properly.
- If the seal is worn out it will have to be replaced.



- The door may need to be adjusted. To do this loosen the door latch bearings and nuts on the door hinge and set the door so it seals tightly against the door jamb. Re-tighten once the door is in place.

If the furnace has an excessive amount of creosote:

- Check to ensure the furnace is sized accurately according to heat demand. If the furnace is oversized it will idle and cause this.
- Check moisture content in your wood fuel. Moisture content over 30% may cause creosote buildup. Recommended moisture content in your wood fuel is 15-25%.
- Remove the access panel at the rear of the furnace and inspect the bypass door for smoke leakage.
- If the chimney and/or heat exchange tubes become plugged with creosote it will be necessary to scrape the

creosote out to obtain a proper burn in the firebox.

You are having to fill the furnace with water more than once a week or more than a few gallons of water per week and there is no obvious explanation:

- Check and confirm that the temperature set-point is not higher than 180 F. Hotter water temperatures will cause increased evaporation.
 - » Check the gaskets on the upper and lower firebox doors. Air leaks in door gaskets will allow continued combustion and potential overheating.
- Check the perimeter of the furnace for water puddles collecting or dripping from the furnace.
- Check all plumbing in the system to ensure there are no leaks.
- If these checks have not provided an answer call your dealer.

TROUBLESHOOTING

ELECTRICAL TROUBLESHOOTING

Electrical troubleshooting should always be done by a qualified technician.

High Limit Switch:

Alarm High Limit should be displayed on the control screen. Using an electrical testing meter check for power on both poles of the high limit switch. If the furnace temperature is above 195° F. the switch should be OPEN and there should only be power on one side of each switch. 24V DC on the red and 115V AC on the black. If the furnace was over 195° F. and the switch has opened the water will need to cool down to approximately 150° F. before it will close and allow power through once again.

- If the furnace has not overheated (195° F+) but there is still power on only one side of the switch, the switch is faulty and should be replaced.
- If there is no power on either side of each switch, check for power at the main power switch at the rear of the furnace.

Control power supply switch:

Using an electrical testing meter check for power on both

poles of the power supply rocker switch. The switch has power in, neutral, and power out poles. During normal operation, there should be power at the power in and power out poles.

- If there is only power on one of the poles, check to make sure the switch is in the “on” position.
- If the switch is “on” and there is only power on one pole the switch is faulty and should be replaced.
- If there is no power on either the power in or the power out pole check for power at the rear main power switch.

Siemens 24V DC Power Supply:

- Using an electrical testing meter check for DC voltage at the OUTPUT terminals.
- If there is 24 volts DC across the terminals and the green LED on the front is illuminated the power supply is working.
- If there is not 24 volts DC check for 115V AC power on the INPUT terminals. If there is no power check for power at the control power switch.

If there is 115V AC on the INPUT terminals but not 24V DC

on the OUTPUT terminals, remove the 24V DC terminal strip from the power supply and test for 24V DC on the output pins. If there is not, the power supply is faulty and should be replaced. If there is power on the pins with the terminal strip removed then it is likely that there is a short circuit in the 24V DC wiring. Locate and repair the issue and re-install the terminal strip.

Fan Motor Breaker:

- If the fan motor breaker has tripped check the fan for proper operation before resetting the breaker. Remove and inspect the fan motor & wheel to confirm it is turning freely.

Siemens LOGO Control: (with display)

- Using an electrical test meter to check for 24V DC power across the "L+" and "M-" terminals.
- If there is 24V DC power at the terminals but the display remains blank the control is faulty and should be replaced.
- If there is not 24V DC power at the terminals, check for power output at the power supply.

Low Water Cut Off Switch:

Check to be sure there is enough water in the tank of the furnace by removing the float assembly and looking in the fill pipe.

- If the water level is low add enough to raise the water level so the float level shows full.
- If the water level is full and the Low Water Alarm is flashing on the screen you will need to test the low water switch.
- Use an electrical test meter to check for voltage across the "M-" and "I1" terminals on the Siemens LOGO control.
- If the low water switch is satisfied (closed) there should be 24V DC.
- If there is no voltage, power off the furnace, remove the Low Water Switch wiring from the control then check for continuity across the switch.
- If the switch has continuity, re-install the wires in their original positions and power up the furnace. The Low Water Alarm should disappear from the screen.
- If the switch does not have continuity, drain the furnace enough so that the water level is below the low water switch. Remove and inspect the switch. If it is dirty it

may be cleaned up, tested and re-installed. If it is faulty it should be replaced.

By-Pass Door Switch:

Test the By-Pass Switch using an electrical test meter. Measure the voltage across the "M-" and "I2" terminals on the Siemens control. There should be 24 VDC when the by-pass is in the CLOSED position.

- If there is no power across those terminals, isolate the switch wiring and perform a continuity test on the switch in the open and closed positions. The circuit should be "open" when the by-pass is OPEN and "closed" when the by-pass is CLOSED
- If this is not the case the switch must be inspected. Check that the switch is wired to the correct terminals and that the magnet is within 1/2" of the sensor when the bypass is in the closed position. If this is all working well but there is no continuity across the switch when the By-Pass is CLOSED then the switch is faulty and should be replaced.

Cold Start Button:

The cold start button will override the low temperature shut down feature of this furnace. It should be pressed once to allow the furnace to operate when in a cold start situation.

If the screen is flashing "Low-Temperature Alarm" and the Cold Start Button is depressed, the Furnace Status should change to "Cold Start Mode". This message will remain until the furnace has heated past its programmed cut in temperature and the mode changes to "Heating Cycle".

If the button is depressed and the "Low-Temperature Alarm" continues, the circuit should be tested using an electrical testing meter. Check for voltage between the "M-" and "I3" terminals on the Siemens control when the button is DEPRESSED. There should be 24V DC across those terminals only when the button is depressed.

- If there is no power present, isolate the switch from the control and wiring and check for continuity across the switch. There should be continuity only when the button is depressed. If not, the button is faulty and should be replaced.

Damper Actuator:

- » Inspect the top and bottom damper plates for proper operation. The target damper position (%) is indicated on the control screen. If the damper plate is not in the

position targeted by the control inspect the plate for creosote, ice, or other build-up. Loosen and clean the plates if necessary.

- » To remove the damper plates remove the two actuator mounting bolts. Remove the actuator and the damper plate should slide off the shaft. If the plate is stuck, pry it off and clean as necessary.
- » The damper plates may be lubricated with a light coating of automatic transmission fluid if necessary.
- » If the damper plate is not stuck but the actuator will not turn test the electrical at the actuator.
- » The "mode" selector should be set to mode 3.
- » Remove the screw in the electrical cover of the actuator. Pull and wiggle gently on the cover to remove it from the actuator. Take care not to damage the electrical pins in the plug.

To test for proper operation the furnace should be powered

on and calling for heat. The display should indicate the target Top and Bottom Air %. In this state, you may test for power across terminals 1 & 2 on the actuator. There should be 24V DC across those terminals.

- If there is no power across terminals 1 & 2 then confirm there is power at the Siemens control. If there is no power at the control check the power supply (see Power Supply Section). The control signal to the actuator can be tested from terminal 2 to 3. There should be 2-10V DC. The actuator position can be confirmed by testing the DC voltage across terminals 2 and 5 on the actuator. It should be 2 to 10V DC depending on the position of the actuator.
- » If the damper plate is not stuck and there is power and communication from the control, the damper actuator is faulty and should be replaced. Please consult your local dealer for assistance.

ELECTRICAL SCHEMATIC

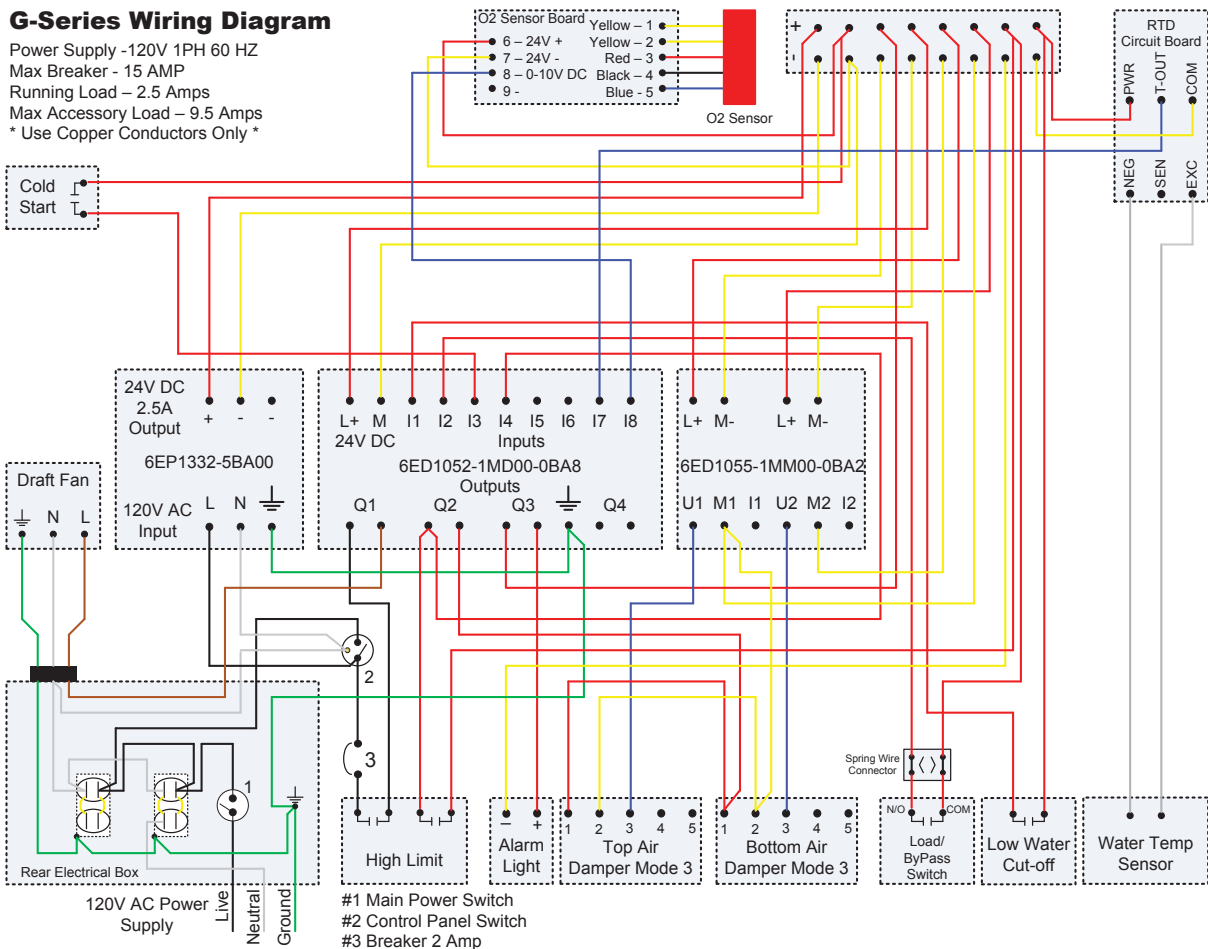

Revision 4.0

INSTRUCTIONS FOR EDITING CONTROL SETTINGS

To edit temperature, differential, timer and low temperature cut off settings follow these instructions:

- To change control settings press the down arrow repeatedly until you reach the desired screen.
- To edit the settings on the screen press and hold the "ESC" key until a black box appears on a variable.
- Use the up/down arrow keys to toggle to different variables on the screen.
- Press the OK button to adjust the highlighted setting
- Use the left/right arrows keys to navigate to the appropriate character.

- Use the up/down arrow keys to adjust the value of the character.

Note: The values are always in minutes, seconds, or degrees Fahrenheit and always positive "+".

- Press the "OK" key to save your changes and adjust other settings.
- Press the "ESC" key to close the black box and toggle between screens.
- Press the "UP" arrow repeatedly to return to the run screen.

The following is a breakdown of the information displayed on your control panel.

Furnace Status (run screen)

F u r n a c e S t a t u s :			
Heat Cycle			
W a t e r	°F	1 6 5 . 4	
O x y g e n	%	7 . 0	
T o p A i r	%	0 . 0	
B o t A i r	%	0 . 0	

This screen displays the primary status information at a glance.

The 2nd line displays the current status mode of the furnace. Heat Cycle, Idle, Timer Cycle, or Cold Start Mode.

Current water temperature, oxygen level, and damper positions are also indicated.

Furnace Run Time

F u r n a c e R u n - T i m e			
T o t a l H o u r s :			
			0
T r i p H o u r s :			
			0
R e s e t	T r i p		O f f

Total Hours displays the accumulated time the furnace has been in a heating cycle.

Trip Hours is a resettable hour meter. IE: You might want to reset this trip meter at the start of your heating season to keep track of hours run in a season.

Reset the meter by changing the reset option to "on"



Water, Differential and Oxygen Settings

S	e	t		W	a	t	e	r		T	e	m	p	:	
										°	F				1 8 0
D	i	f	f	e	r	e	n	t	i	a	l	:			
										°	F				2 0
O	x	y	g	e	n	:									
										%					5 . 0

Set Water Temp is the temperature at which the furnace will turn off at the end of a heating cycle.

The differential controls how many degrees the water will lose before the furnace turns on to heat the water.

Oxygen: The target oxygen level in the exhaust stream during a heating cycle. This affects the bottom damper position.

Set Low Temperature Shut Down

S	e	t		L	o	w		T	e	m	p				
S	h	u	t		D	o	w	n	:						
										°	F				1 4 0

When the furnace water cools below this setpoint, it will assume the firebox is empty and will shut down to conserve heat.

Idle Timer Settings

I	d	l	e		T	i	m	e	r	:					
D	e	l	a	y						0	1	:	3	0	h
O	n		T	i	m	e				0	3	:	0	0	m
O	f	f		T	i	m	e			3	0	:	0	0	m

This timer can be used to keep the coal bed alive during long idle periods. Once the furnace shuts down at the end of the heating cycle the initial timer will start (Factory Set Delay - 1 hour and 30 minutes). Once this Delay time has passed the furnace will start the fan and open the dampers to provide air to the coal bed for the set On Time (3 Minutes and 0 Seconds). After this first cycle the control will run the On Time cycle every Off Time (30 minutes and 0 seconds).

By-Pass Door Is Open

		*		B	Y	-	P	A	S	S	*				
				D	O	O	R		I	S					
										O	P	E	N		

Opening the smoke by-pass will activate the draft fan for a maximum of 5 minutes. If more time is needed the by-pass must be closed and opened again. Operating the smoke by-pass for extended periods of time may over heat the motor causing premature failure.

Alarm - Low Water

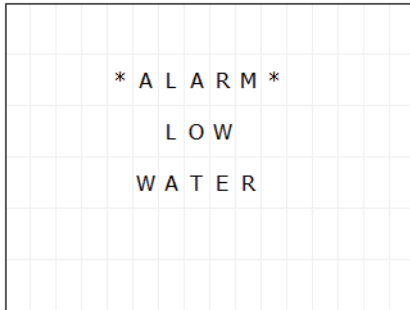

The water level sensor is indicating the water level is below the safe operating level in the reservoir. Add water to clear the alarm. Top off the fluid level once the fluid is back up to normal operating temperature.

Alarm – Low Temperature Shut Down

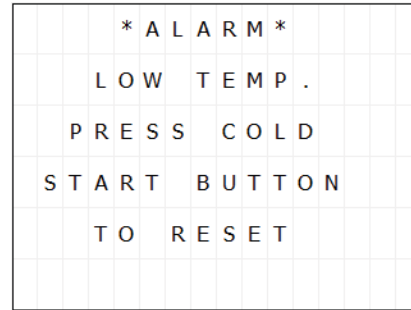

The water temperature has dropped below the Low Temperature Shut Down setpoint. The furnace shuts down to conserve heat assuming the firebox is empty and needs to be reloaded.

Alarm - By-pass Open Over-time Shut Down

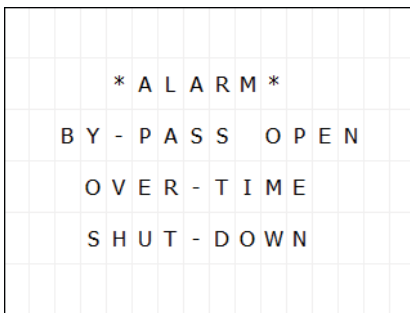

Opening the smoke by-pass will activate the draft fan for a maximum of 5 minutes. If more time is needed, the by-pass must be closed and opened again. Operating the smoke by-pass for extended periods of time may overheat the motor causing premature failure.

Alarm – High Temperature

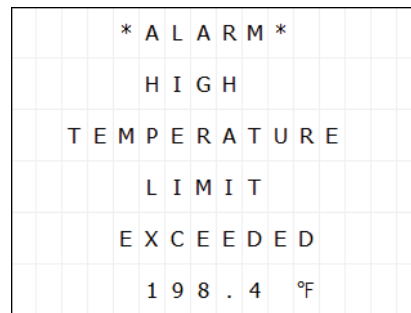

The high temperature limit switch has been activated (195 F). The furnace will remain off until the water cools to approximately 160 F.



HOME NETWORK CONNECTION FOR YOUR HEATMASTER FURNACE

This instruction applies to G-Series furnaces that were manufactured as a part of the 2020 model lineup using the Siemens Logo Control.

Choose one of the two connection options listed below to setup and access your furnace control from any web browser enabled device on your home network.

- 1** **1A** Hardwired Connection: This is the preferred and recommended method to connect your furnace to your home network. See page 31 for these
- 1B** Wireless Connection: This alternate method requires the installation of a wireless access device. This is available as part of the HeatMaster Wireless Access Kit. Please contact your dealer for more information.
- 2** After you have setup the hardwired connection you will need to next find an IP address that you can use on your home network. See page 32 for these instructions.
- 3** Assign your furnace an IP address. See page 33 for these instructions.
- 4** Once you have followed these steps you should be able to access your furnace on your home network via an internet browser. See page 35 for these instructions.

HARDWIRED CONNECTION

Hardwired LAN Line: This is the preferred method to connect your furnace to your home network.

You will need to run and connect a Cat 5 or 6 cable from your home router or network switch to the ethernet jack in the rear cabinet of your furnace. If you need to bury the cable make sure it is rated for burial and outdoor use. The maximum recommended distance that you can run a Cat 5 or 6 cable is 328ft.

In the next step you will search your network for an available IP address for your furnace. Once you have assigned your furnace control an IP address you will be able to access the furnace from any device with a web browser connected to your network.

Go to the "Finding your IP address" page in this manual. See page 32 for these instructions.

FINDING AN IP ADDRESS FOR YOUR FURNACE

These instructions will guide you in finding an available address on your home network to assign to your HeatMaster furnace.

Using a windows PC that is running on your home network, we'll use the command prompt app. Using the search bar in the lower left corner of your Windows home screen, enter the letters "cmd", and then hit enter as shown in figure 1, the command prompt app loads.

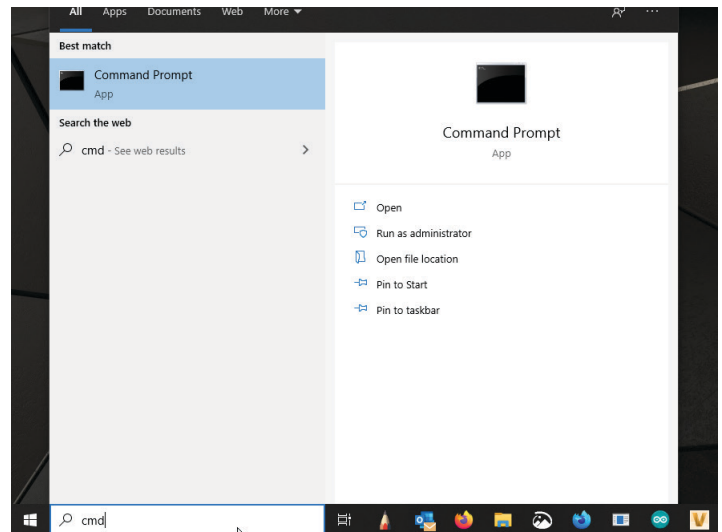

Figure 1

Next you will see a window similar to the one in figure 2. Enter the command "ipconfig". You'll see a screen with similar data as shown in figure 3.

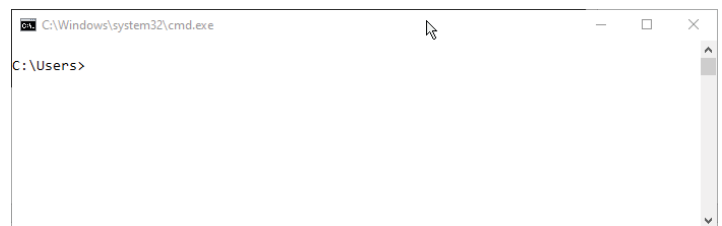

Figure 2

Paying attention to the addresses that we've highlighted within the square (in figure 3), you'll need to take note of three addresses.

The line "IPv4 Address" is the IP address of the computer that you are currently working on. The IP address that you'll be assigning to your furnace will be in the same range as this number.

The line "Subnet Mask" is the same Subnet address that you'll be assigning to your furnace.

The line "Default Gateway" is an address that you need to confirm or assign to your furnace.

Note these three addresses, as you'll need them later.

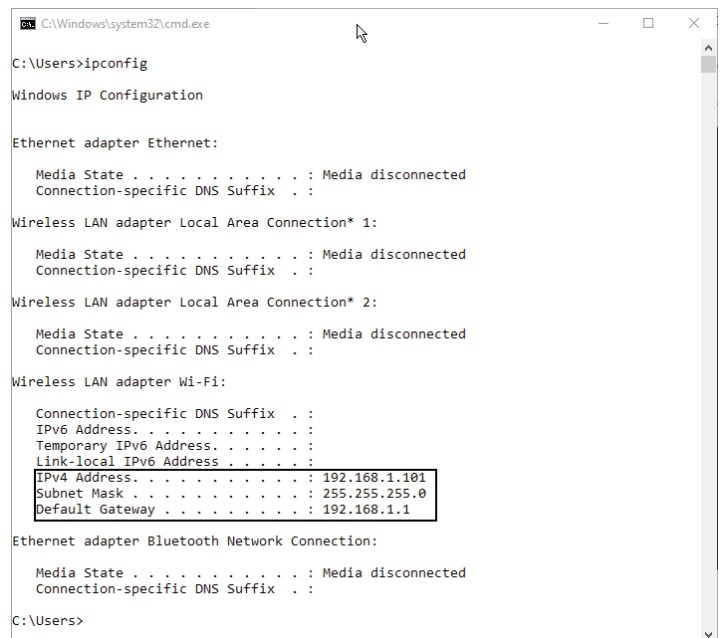

Figure 3

FINDING AN IP ADDRESS FOR YOUR FURNACE (CONTINUED)

In this same window we will ping a few addresses and find one available to use for your furnace.

Start by pinging your computers IP address that you found in the previous window (in our case this is 192.168.1.101).

Enter the ping command as shown in the first box in figure 4, using your computers IP address (ping *****.***.**.*****).

The following lines (as shown in the second box in figure 4) show that the computer is getting a reply from that address, indicating that this IP address is already in use and can't be used for your furnace.

Change your the last 3 digits (Figure 5) of your IP address to a number between 200-250, to ping an address with a higher number as your router is less likely to assign an address within this range. Only change the last three numbers in the address as shown in figure 5.

You may need to try a few different numbers before you will find an available address. Once you find an IP address that is available you will see a message saying "Request timed out", as shown in Figure 6.

Write down this IP address (in our case 192.168.1.250). This will be the address we will assign to your furnace in the next step of this instruction.

Go to the "Addressing Your Furnace" page. See page 34 for these instructions.

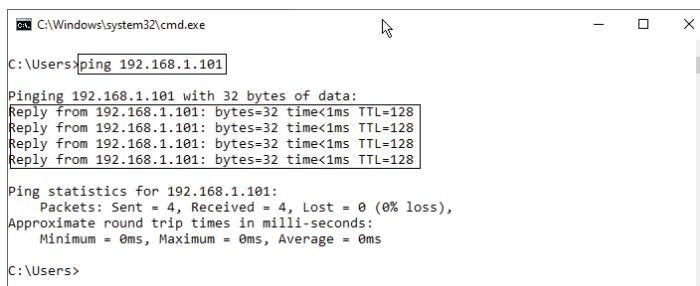

```
C:\Windows\system32\cmd.exe
C:\Users>ping 192.168.1.101

Pinging 192.168.1.101 with 32 bytes of data:
Reply from 192.168.1.101: bytes=32 time<1ms TTL=128
Reply from 192.168.1.101: bytes=32 time<1ms TTL=128
Reply from 192.168.1.101: bytes=32 time<1ms TTL=128
Reply from 192.168.1.101: bytes=32 time<1ms TTL=128

Ping statistics for 192.168.1.101:
    Packets: Sent = 4, Received = 4, Lost = 0 (0% loss),
    Approximate round trip times in milli-seconds:
        Minimum = 0ms, Maximum = 0ms, Average = 0ms

C:\Users>
```

Figure 4

Change These
192.168.1.101

Figure 5

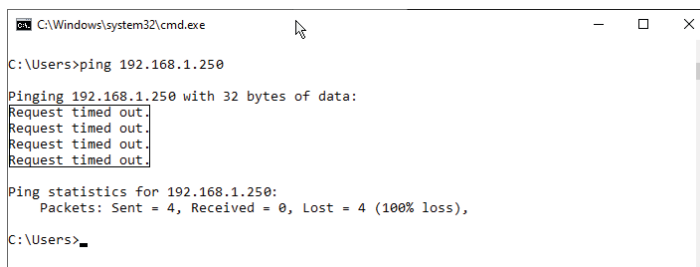

```
C:\Windows\system32\cmd.exe
C:\Users>ping 192.168.1.250

Pinging 192.168.1.250 with 32 bytes of data:
Request timed out.
Request timed out.
Request timed out.
Request timed out.

Ping statistics for 192.168.1.250:
    Packets: Sent = 4, Received = 0, Lost = 4 (100% loss),

C:\Users>
```

Figure 6

ADDRESSING YOUR FURNACE

Now that we have obtained an available IP address, we will assign this address to the furnace control.

Power on the furnace.

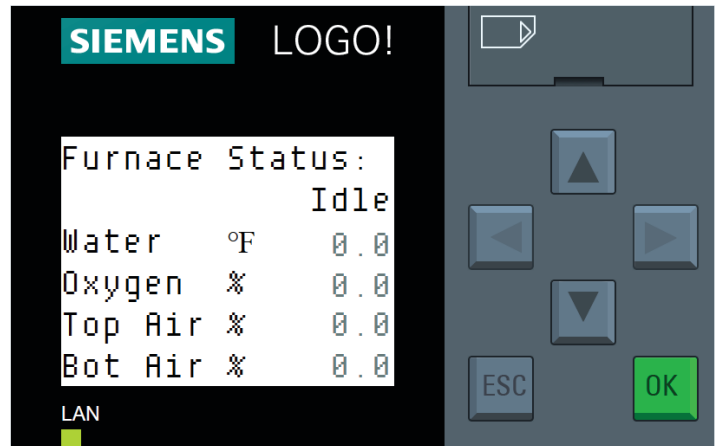

Press the down arrow key repeatedly to scroll to the last available screen displaying date and time as shown above.

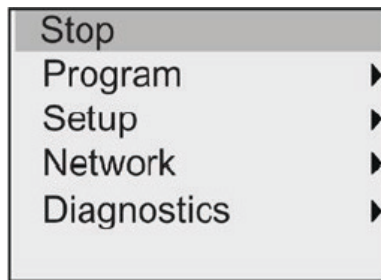

Press the ESC key, you should see the screen shown above. We need to stop the Logo's program to make this IP address change. Select STOP and press the OK button.

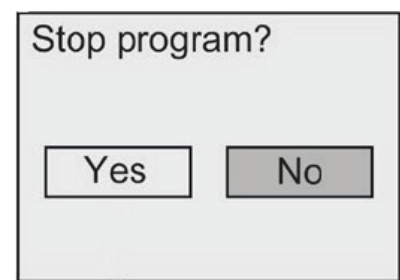

Select Yes.

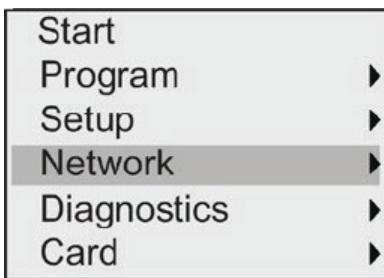

Select Network

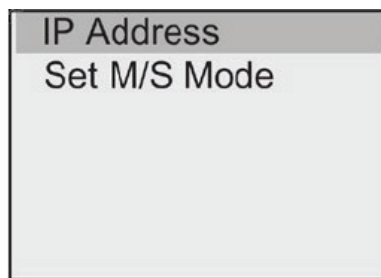

Select IP Address

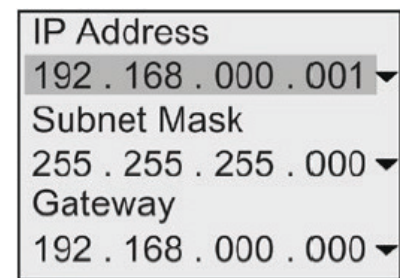

Using the four arrow keys, change the IP address to the one you found to be available on your network in the previous section. Also change the subnet mask, and the gateway addresses to match the numbers you wrote down earlier.

ADDRESSING YOUR FURNACE (CONTINUED)

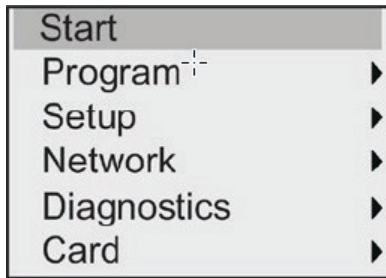

After you have set these three addresses, scroll back and restart the furnace by selecting start

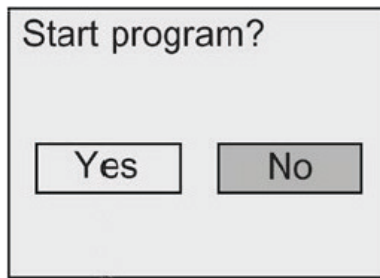

Select Yes to start the Logo's program again.

At this point you should be able to access your furnace on your home network.

Go to the "Viewing Your Furnace in a Web Browser". See below for these instructions.

VIEWING YOUR FURNACE IN A WEB BROWSER

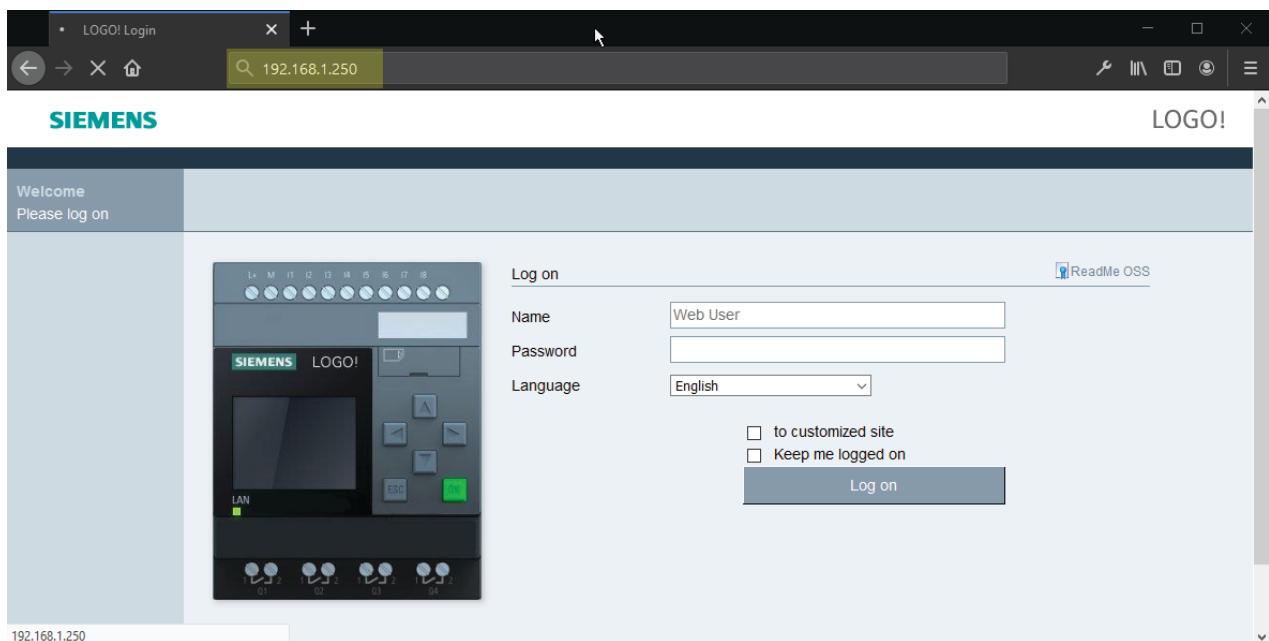

Figure 1

The last step in these instructions is loading and viewing your furnace control system on your computer.

- Load a web browser on a device connected to your home network.
- As shown in figure 1, enter the IP address that you programmed into your furnace control, in our case this is 192.168.1.250. Enter this in the browser URL and hit enter.
- Leave the name field as Web User.
- Enter the password "heatmaster", then click "log on".

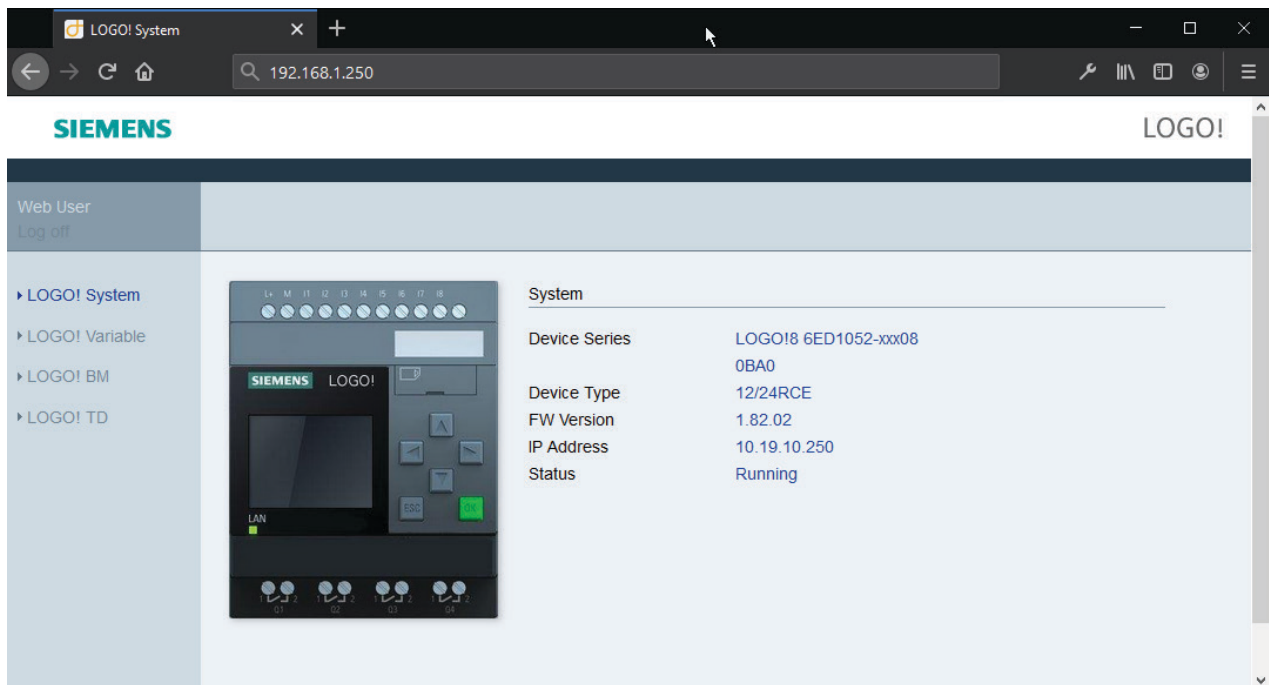

Figure 2

The Screen that you see in figure 2 should load

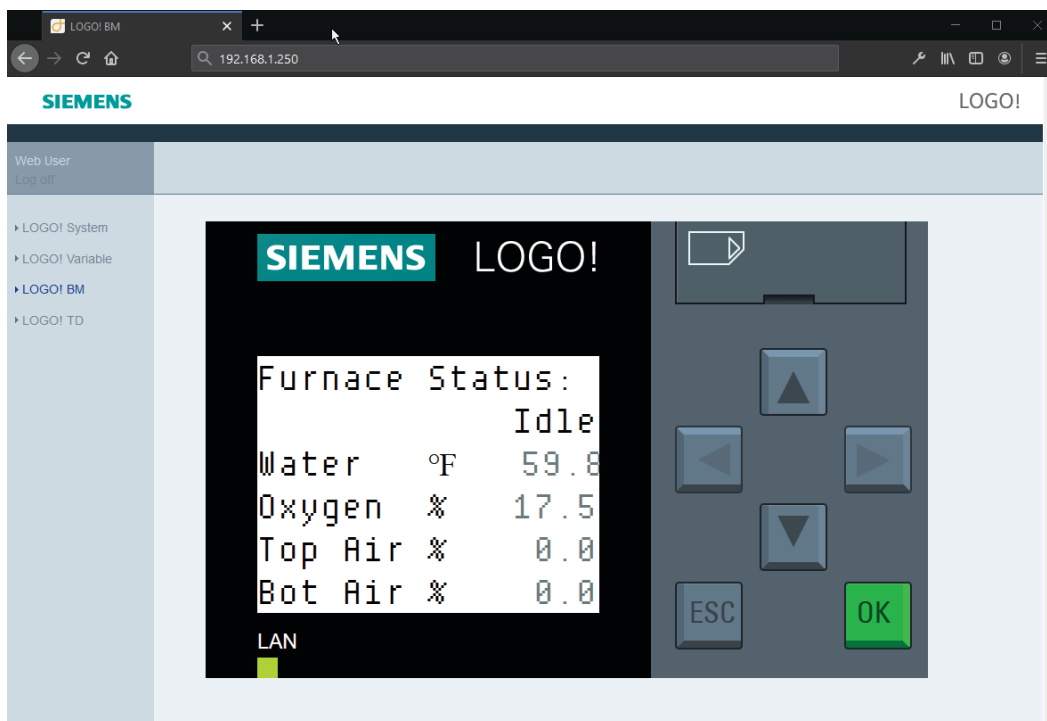

Figure 3

Select the menu option “LOGO! BM” on the left side of the screen.

You can use the control buttons on the screen to navigate the furnace control just as if you were standing at your furnace.

This page can be accessed from any web browser enabled device connected to your home network.

Bookmark this page in your web browser, allowing you quick access to this page at any time.



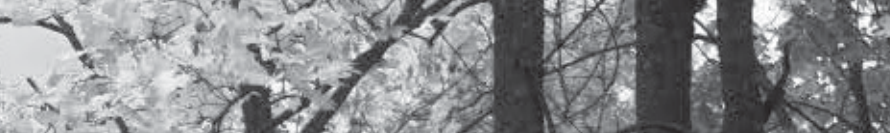



HeatMaster^{SS} carries a full line of high-quality parts for your furnace including pumps, fittings and heat exchangers. For more information on our parts or to arrange product installation please contact your local HeatMaster^{SS} dealer.

HeatMaster^{SS}

Box 158
Winkler, Manitoba, Canada
R6W 4A4

Phone: (204) 325-9792
Fax: (204) 325-9803
Toll Free: 1-877-325-9792

Email: info@heatmasterss.com

heatmasterss.com

